

Read this “Basic Guide” and keep it handy for future reference.

## Basic Guide HITACHI S1 Series Inverter

S1



Preface

Contents

Chapter 1: Safety precautions

Chapter 2: Quick startup

Chapter 3: Product overview

Chapter 4: Installation Guide

Chapter 5: Basic operation instructions

Chapter 6: Function parameter list

Chapter 7: Troubleshooting

Chapter 8: Maintenance and hardware fault diagnosis

Chapter 9: Communication protocol

Chapter 10: Technical data

Chapter 11: Dimension drawings

Chapter 12: Optional peripheral accessories

Chapter 13: STO function description

Chapter 14: Further information

If you have any inquiry or problem,  
Refer to Chapter 7 Troubleshooting  
or  
Contact to the Technical Inquiry Service  
for Inverter.

When contacting us, please mention  
the below reference number.

**BG-S1-05/20EN**

## Preface

Thank you for purchasing Hitachi S1 series inverter. This is a user's guide for handling and maintenance of Hitachi S1 series inverter.

S1 is a standard inverter aiming to drive asynchronous motor. It is equipped with advanced vector control technology and the latest digital processor dedicated for motor control, thus enhancing product reliability and adaptability to the environment. S1 series inverter adopts customized and industrialized design to realize excellent control performance through optimized functions and flexible applications.

S1 series inverter uses high power density design. Some power ranges carry built-in DC reactor and brake unit to save installation space. Through overall EMC design, it can satisfy the low noise and low electromagnetic interference requirements to cope with challenging grid, temperature, humidity and dust conditions, thus greatly improving product reliability.

■ This document presents installation wiring, parameter setup, fault diagnosis and trouble shooting, and precautions related to daily maintenance. Read through this document carefully before installation to ensure S1 series inverter is installed and operated in a proper manner to make a correct use of its excellent performance and powerful functions.

■ Handling of optional products

If you use the inverter with optional products, also you should read the manuals enclosed with those product

■ For the proper use of the inverter

Please read the User's Guide before operation of the inverter to perfectly understand proper handling and safety precautions for the product to ensure safety and proper usage.

Before attempting installation, operation, maintenance, and inspection work, you should understand the knowledge of equipment, information of safety, caution and how to use and service the inverter.

■ Cautions

No part of the document may be reproduced or reformed in any form without the publisher's permission.

The contents of this document are subject to change without prior notice.

You "CANNOT DO" what is not described in this manual. In addition, do not operate the product in a manner not specified in the manual. An unexpected failure or accident may occur.

If you find any unclear or incorrect description, missing description, misplaced or missing pages, or have a question concerning the contents of the manual, please contact the publisher.

We are not responsible for any impact from operations regardless of the above. We apologize in advance for any inconvenience this may cause.

If you find any unclear or incorrect description, missing description, or misplaced or missing pages, please take time to contact the Technical Inquiry Service for Inverter found on the back cover.

## Contents

<b>Preface</b> .....	<b>i</b>
<b>Contents</b> .....	<b>ii</b>
<b>Chapter 1 Safety precautions</b> .....	<b>1</b>
1.1 What this chapter contains .....	1
1.2 Safety definition .....	1
1.3 Warning symbols .....	1
1.4 Safety guidelines .....	2
<b>Chapter 2 Quick startup</b> .....	<b>5</b>
2.1 What this chapter contains .....	5
2.2 Unpack inspection .....	5
2.3 Application confirmation .....	5
2.4 Environment confirmation .....	5
2.5 Installation confirmation .....	6
2.6 Basic commissioning .....	6
<b>Chapter 3 Product overview</b> .....	<b>8</b>
3.1 What this chapter contains .....	8
3.2 Basic principle .....	8
3.3 Product specification .....	9
3.4 Product nameplate .....	12
3.5 Type designation key .....	12
3.6 Rated value .....	13
3.7 Structure diagram .....	14
<b>Chapter 4 Installation guide</b> .....	<b>15</b>
4.1 What this chapter contains .....	15
4.2 Mechanical installation .....	15
4.3 Standard wiring of main circuit .....	21
4.4 Standard wiring of control circuit .....	26
4.5 Wiring protection .....	31
<b>Chapter 5 Basic operation instructions</b> .....	<b>33</b>
5.1 What this chapter contains .....	33
5.2 Keypad introduction .....	33
5.3 Keypad display .....	35
5.4 Keypad operation .....	36
5.5 Basic operation instruction .....	38
<b>Chapter 6 Function parameter list</b> .....	<b>92</b>
6.1 What this chapter contains .....	92
6.2 Function parameter list .....	92
<b>Chapter 7 Troubleshooting</b> .....	<b>156</b>
7.1 What this chapter contains .....	156

7.2	Indications of alarms and faults .....	156
7.3	Fault reset.....	156
7.4	Fault history .....	156
7.5	Inverter faults and solutions.....	156
7.6	Analysis on common faults .....	161
7.7	Countermeasures on common interference .....	168
<b>Chapter 8</b>	<b>Maintenance and hardware fault diagnosis.....</b>	<b>172</b>
8.1	What this chapter contains .....	172
8.2	Periodical inspection .....	172
8.3	Cooling fan.....	174
8.4	Capacitor .....	175
8.5	Power cable.....	177
<b>Chapter 9</b>	<b>Communication protocol.....</b>	<b>178</b>
9.1	What this chapter contains .....	178
9.2	Modbus protocol introduction .....	178
9.3	Application of Modbus .....	178
9.4	RTU command code and communication data.....	184
9.5	Common communication faults .....	199
<b>Chapter 10</b>	<b>Technical data.....</b>	<b>200</b>
10.1	What this chapter contains .....	200
10.2	Derated application .....	200
10.3	Grid specifications.....	201
10.4	Motor connection data.....	201
10.5	Application standards .....	202
10.6	EMC regulations .....	202
<b>Chapter 11</b>	<b>Dimension drawings .....</b>	<b>204</b>
11.1	What this chapter contains .....	204
11.2	400V Keypad structure .....	204
11.3	Inverter structure .....	205
11.4	Dimensions of Inverters.....	205
<b>Chapter 12</b>	<b>Optional peripheral accessories .....</b>	<b>213</b>
12.1	What this chapter contains .....	213
12.2	Wiring of peripheral accessories.....	213
12.3	Power supply .....	215
12.4	Cables .....	215
12.5	Breaker and electromagnetic contactor .....	219
12.6	Reactors .....	220
12.7	Filters.....	222
12.8	Brake system .....	224
<b>Chapter 13</b>	<b>STO function description .....</b>	<b>227</b>
13.1	STO function logic table .....	227

S1 series standard inverter

---

13.2 STO channel delay description .....	228
13.3 STO function installation checklist .....	228
<b>Chapter 14 Further information.....</b>	<b>229</b>
14.1 Product and service queries .....	229
14.2 Feedback on HITACHI inverter manuals .....	229
14.3 Documents on the Internet .....	229

## Chapter 1 Safety precautions

### 1.1 What this chapter contains

Read this manual carefully and follow all safety precautions before moving, installing, operating and servicing the inverter. If these safety precautions are ignored, physical injury or death may occur, or damage may occur to the equipment.

If any physical injury or death or damage to the equipment occur due to neglect of the safety precautions in the manual, our company will not be responsible for any damages and we are not legally bound in any manner.

### 1.2 Safety definition

**Danger:** Serious physical injury or even death may occur if related requirements are not followed.













**Warning:** Physical injury or damage to the equipment may occur if related requirements are not followed.



**Note:** Procedures taken to ensure proper operation.

**Qualified electricians:** People working on the device should take part in professional electrical and safety training, receive the certification and be familiar with all steps and requirements of installing, commissioning, operating and maintaining the device to prevent any emergencies.





### 1.3 Warning symbols

Warnings caution you about conditions which can result in serious injury or death and/or damage to the equipment, and advice on how to avoid the danger. Following warning symbols are used in this manual.

Symbols	Name	Instruction	Abbreviation
 Danger	Danger	Serious physical injury or even death may occur if related requirements are not followed	
 Warning	Warning	Physical injury or damage to the equipment may occur if related requirements are not followed	
 Forbid	Electrostatic discharge	Damage to the PCBA board may occur if related requirements are not followed	
 Hot	Hot sides	The base of the inverter may become hot. Do not touch.	
  5 min	Electric shock	As high voltage still presents in the bus capacitor after power off, wait for at least five minutes (or 15 min / 25 min, depending on the warning symbols on the machine) after power	  5 min

Symbols	Name	Instruction	Abbreviation
		off to prevent electric shock	
	Read manual	Read the operation manual before operating on the equipment	
<b>Note</b>	Note	Procedures taken to ensure proper operation	<b>Note</b>

### 1.4 Safety guidelines

	<ul style="list-style-type: none"> <li>◇ Only trained and qualified electricians are allowed to carry out related operations.</li> <li>◇ Do not perform wiring, inspection or component replacement when power supply is applied. Ensure all the input power supplies are disconnected before wiring and inspection, and wait for at least the time designated on the inverter or until the DC bus voltage is less than 36V. The minimum waiting time is listed in the table below.</li> </ul>															
	<table border="1"> <thead> <tr> <th colspan="2">Inverter model</th> <th>Minimum waiting time</th> </tr> </thead> <tbody> <tr> <td>230V</td> <td>0.4kW–2.2kW</td> <td>5 min</td> </tr> <tr> <td>400V</td> <td>0.75kW–110kW</td> <td>5 min</td> </tr> <tr> <td>400V</td> <td>132kW–315kW</td> <td>15 min</td> </tr> <tr> <td>400V</td> <td>Above 355kW</td> <td>25 min</td> </tr> </tbody> </table>	Inverter model		Minimum waiting time	230V	0.4kW–2.2kW	5 min	400V	0.75kW–110kW	5 min	400V	132kW–315kW	15 min	400V	Above 355kW	25 min
	Inverter model		Minimum waiting time													
	230V	0.4kW–2.2kW	5 min													
	400V	0.75kW–110kW	5 min													
400V	132kW–315kW	15 min														
400V	Above 355kW	25 min														
	◇ Do not refit the inverter unless authorized; otherwise, fire, electric shock or other injuries may occur.															
	◇ The base of the radiator may become hot during running. Do not touch to avoid hurt.															
	◇ The electrical parts and components inside the inverter are electrostatic. Take measures to prevent electrostatic discharge during related operation.															

#### 1.4.1 Delivery and installation

	<ul style="list-style-type: none"> <li>◇ Install the inverter on fire-retardant material and keep the inverter away from combustible materials.</li> <li>◇ Connect the optional brake parts (brake resistors, brake units or feedback units) according to the wiring diagram.</li> <li>◇ Do not operate on a damaged or incomplete inverter.</li> <li>◇ Do not touch the inverter with wet items or body parts; otherwise, electric shock may occur.</li> </ul>
---	---

**Note:**

- ◇ Select appropriate tools for delivery and installation to ensure a safe and proper running of the inverter and avoid physical injury or death. To ensure physical safety, the installation staff should take mechanical protective measures like wearing exposure shoes and working uniforms;
- ◇ Ensure to avoid physical shock or vibration during delivery and installation;
- ◇ Do not carry the inverter by its front cover only as the cover may fall off;

## S1 series standard inverter

---

- ◇ Installation site should be away from children and other public places;
- ◇ The inverter cannot meet the requirements of low voltage protection in IEC61800-5-1 if the altitude of installation site is above 2000m;
- ◇ The inverter should be used in proper environment (see chapter 4.2.1 Installation environment for details);
- ◇ Prevent the screws, cables and other conductive parts from falling into the inverter;
- ◇ As leakage current of the inverter during running may exceed 3.5mA, ground properly and ensure the grounding resistance is less than 10Ω. The conductivity of PE grounding conductor is the same with that of the phase conductor (with the same cross sectional area).
- ◇ L, N (230V) or R, S and T (400V) are the power input terminals, and U, V and W are output motor terminals. Connect the input power cables and motor cables properly; otherwise, damage to the inverter may occur.

### 1.4.2 Commissioning and running

	<ul style="list-style-type: none"><li>◇ Disconnect all power sources applied to the inverter before terminal wiring, and wait for at least the time designated on the inverter after disconnecting the power sources.</li><li>◇ High voltage presents inside the inverter during running. Do not carry out any operation on the inverter during running except for keypad setup. For products at voltage levels of 5 or 6, the control terminals form extra-low voltage circuits. Therefore, you need to prevent the control terminals from connecting to accessible terminals of other devices.</li><li>◇ The inverter may start up by itself when P01.21 (restart after power down) is set to 1. Do not get close to the inverter and motor.</li><li>◇ The inverter cannot be used as "Emergency-stop device".</li><li>◇ The inverter cannot act as an emergency brake for the motor; it is a must to install mechanical brake device.</li></ul>
---	--

#### Note:

- ◇ Do not switch on or switch off input power sources of the inverter frequently;
- ◇ For inverters which have been stored for a long time, set the capacitance and carry out inspection and pilot run on the inverter before use.
- ◇ Close the front cover before running; otherwise, electric shock may occur.

### 1.4.3 Maintenance and component replacement



	<ul style="list-style-type: none"><li>◇ Only well-trained and qualified professionals are allowed to perform maintenance, inspection, and component replacement on the inverter.</li><li>◇ Disconnect all the power sources applied to the inverter before terminal wiring, and wait for at least the time designated on the inverter after disconnecting the power sources.</li><li>◇ Take measures to prevent screws, cables and other conductive matters from falling into the inverter during maintenance and component replacement.</li></ul>
---	--



**Note:**

- ◇ Use proper torque to tighten the screws.
- ◇ Keep the inverter and its parts and components away from combustible materials during maintenance and component replacement.
- ◇ Do not carry out insulation voltage-endurance test on the inverter, or measure the control circuits of the inverter with megameter.
- ◇ Take proper anti-static measures on the inverter and its internal parts during maintenance and component replacement.

**1.4.4 What to do after scrapping**

	◇ The heavy metals inside the inverter should be treated as industrial effluent.
	◇ When the life cycle ends, the product should enter the recycling system. Dispose of it separately at an appropriate collection point instead of placing it in the normal waste stream.

## Chapter 2 Quick startup

### 2.1 What this chapter contains

This chapter introduces the basic principles required during installation commissioning. Users can realize quick installation commissioning by following these principles.

### 2.2 Unpack inspection

Check as follows after receiving products.

1. Check whether the packing box is damaged or dampened. If yes, contact local dealers or HITACHI offices.
2. Check the model identifier on the exterior surface of the packing box is consistent with the purchased model. If no, contact local dealers or HITACHI offices.
3. Check whether the interior surface of packing box is improper, for example, in wet condition, or whether the enclosure of the inverter is damaged or cracked. If yes, contact local dealers or HITACHI offices.
4. Check whether the nameplate of the inverter is consistent with the model identifier on the exterior surface of the packing box. If not, contact local dealers or HITACHI offices.
5. Check whether the accessories (including user's manual, control keypad and extension card units) inside the packing box are complete. If not, contact local dealers or HITACHI offices.

### 2.3 Application confirmation

Check the following items before operating on the inverter.

1. Verify the load mechanical type to be driven by the inverter, and check whether overload occurred to the inverter during actual application, or whether the inverter power class needs to be enlarged?
2. Check whether the actual running current of load motor is less than rated inverter current.
3. Check whether the control precision required by actual load is the same with the control precision provided by the inverter.
4. Check whether the grid voltage is consistent with rated inverter voltage.
5. Check whether the functions required need an optional extension card to be realized.

### 2.4 Environment confirmation

Check the following items before use.

1. Check whether the ambient temperature of the inverter during actual application exceeds 40°C, if yes, derate 1% for every additional 1°C. In addition, do not use the inverter when the ambient temperature exceeds 50°C. <b>Note:</b> For cabinet-type inverter, its ambient temperature is the air temperature inside the cabinet.
2. Check whether ambient temperature of the inverter during actual application is below -10°C, if yes, install heating facility.

<b>Note:</b> For cabinet-type inverter, its ambient temperature is the air temperature inside the cabinet.
3. Check whether the altitude of the application site exceeds 1000m, if yes, derate 1% for every additional 100 m.
4. Check whether the humidity of application site exceeds 90%, if yes, check whether condensation occurred, if condensation does exist, take additional protective measures.
5. Check whether there is direct sunlight or animal intrusion in the application site, if yes, take additional protective measures.
6. Check whether there is dust, explosive or combustible gases in the application site, if yes, take additional protective measures.

## 2.5 Installation confirmation

After the inverter is installed properly, check the installation condition of the inverter.

1. Check whether the input power cable and current-carrying capacity of the motor cable fulfill actual load requirements.
2. Check whether peripheral accessories (including input reactors, input filters, output reactors, output filters, DC reactors, brake units and brake resistors) of the inverter are of correct type and installed properly; check whether the installation cables fulfill requirements on current-carrying capacity.
3. Check whether the inverter is installed on fire-retardant materials; check whether the hot parts (reactors, brake resistors, etc.) are kept away from combustible materials.
4. Check whether all the control cables are routed separately with power cables based on EMC requirement.
5. Check whether all the grounding systems are grounded properly according to inverter requirements.
6. Check whether installation spacing of the inverter complies with the requirements in operation manual.
7. Check whether installation mode of the inverter complies with the requirements in operation manual. Vertical installation should be adopted whenever possible.
8. Check whether external connecting terminals of the inverter are firm and tight enough, and whether the moment is up to the requirement.
9. Check whether there are redundant screws, cables or other conductive objects inside the inverter, if yes, take them out.

## 2.6 Basic commissioning

Carry out basic commissioning according to the following procedures before operating on the inverter.

1. Select motor type, set motor parameters and select inverter control mode according to actual motor parameters.
2. Whether autotuning is needed? If possible, disconnect the motor load to carry out dynamic parameter autotuning; if the load cannot be disconnected, perform static autotuning.

## S1 series standard inverter

---

- |   |
|---|
| 3. Adjust the acceleration and deceleration time based on actual working conditions of the load.  |
| 4. Jogging to carry out device commissioning. Check whether the motor running direction is consistent with the direction required, if no, it is recommended to change the motor running direction by exchanging the motor wiring of any two phases. |
| 5. Set all the control parameters, and carry out actual operation.  |

## Chapter 3 Product overview

### 3.1 What this chapter contains

This chapter mainly introduces the operation principles, product features, layouts, nameplates and model instructions.

### 3.2 Basic principle

S1 series inverter is used to control asynchronous AC induction motor. The figure below shows the main circuit diagram of the inverter. The rectifier converts AC voltage into DC voltage, and the inverter converts DC voltage into the AC voltage used by AC motor.

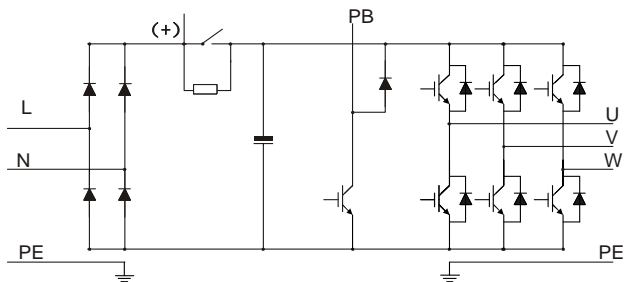

Fig 3.1 230V main circuit diagram

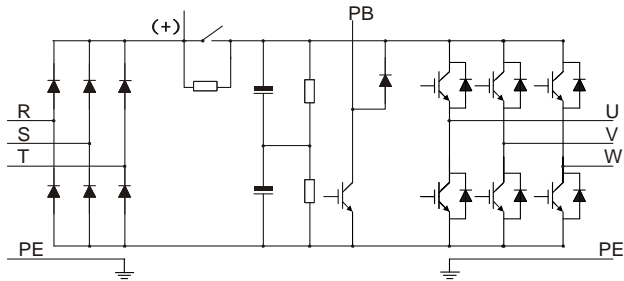

Fig 3.2 400V (0.75kW-2.2kW) main circuit diagram

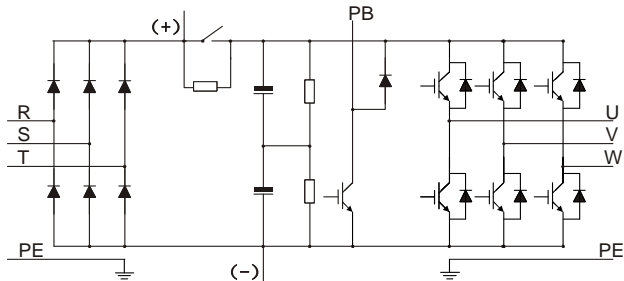

Fig 3.3 400V (4kW-15kW) main circuit diagram

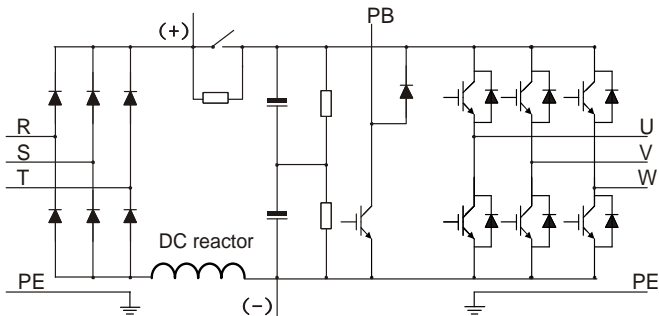

Fig 3.4 400V (18.5kW-110kW) main circuit diagram

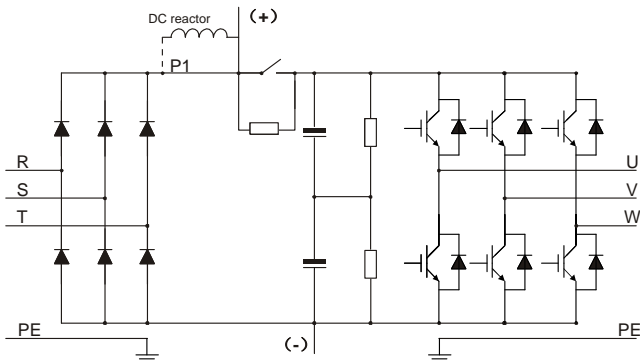

Fig 3.5 400V (132kW and above) main circuit diagram

**Note:**

1. 132kW and above inverters can be connected to external DC reactors. Before connection, it is required to take off the copper bar between P1 and (+). 132kW and above inverters can be connected to external brake unit. DC reactors and brake units are optional parts.
2. 18.5kW-110kW inverters are equipped with built-in DC reactor.
3. 37kW and below models carry built-in brake units, 45kW-55kW supports built-in brake unit. 75kW-400kW supports external brake unit. The models that carry built-in brake unit can also be connected to external brake resistor. The brake resistor is optional part.

**3.3 Product specification**

Function description		Specification
Power input	Input voltage (V)	AC 1PH 220V (-15%)–240V (+10%) rated voltage: 230V AC 3PH 380V (-15%)–440V (+10%) rated voltage: 400V
	Input current (A)	Refer to <i>Rated value</i>
	Input frequency (Hz)	50Hz or 60Hz, allowable range: 47–63Hz
Power output	Output voltage (V)	0–input voltage
	Output current (A)	Refer to <i>Rated value</i>

S1 series standard inverter

Function description		Specification
	Output power (kW)	Refer to Rated value
	Output frequency (Hz)	0–400Hz
Technical control performance	Control mode	V/F control, SVC
	Motor type	Asynchronous motor
	Speed regulation ratio	Asynchronous motor 1: 100 (SVC); models <4kW Asynchronous motor 1: 200 (SVC); models ≥4kW
	Speed control precision	± 0.2% (SVC)
	Speed fluctuation	± 0.3% (SVC)
	Torque response	<20ms (SVC)
	Torque control precision	± 10% (SVC)
	Starting torque	Asynchronous motor: 0.25Hz/150% (SVC)
	Overload capacity	ND: 150% of rated current: 1min 180% of rated current: 10s 200% of rated current: 1s LD: 120% of rated current: 1min 150% of rated current: 10s 180% of rated current: 1s
Running control performance	Frequency setup mode	Digital, analog, pulse frequency, multi-step speed running, PID, Modbus communication Realize switch-over between the set combination and the set channel
	Automatic voltage regulation function	Keep the output voltage constant when grid voltage changes
	Fault protection function	Fault protection function Provide over 30 kinds of fault protection functions: overcurrent, overvoltage, undervoltage, over-temperature, phase loss and overload, etc
	Speed tracking restart function	Realize impact-free starting of the motor in rotating Note: This function is available for 4kW and above models
Peripheral interface	Terminal analog input resolution	No more than 20mV
	Terminal digital input resolution	No more than 2ms
	Analog input	2 inputs AI2: 0–10V/0–20mA; AI3: -10–10V; models <4kW AI1: 0–10V/0–20mA; AI2: -10–10V; models ≥4kW

S1 series standard inverter

Function description		Specification
	Analog output	1 output, AO1: 0–10V /0–20mA
	Digital input	Four regular inputs; max. frequency: 1kHz; internal impedance: 3.3kΩ Two high-speed inputs; max. frequency: 50kHz Note: up to 2.2kW only there is 1 channel HDI
	Digital output	One high-speed pulse output; max. frequency: 50kHz One Y terminal open collector output
	Relay output	Two programmable relay outputs RO1A NO, RO1B NC, RO1C common port RO2A NO, RO2B NC, RO2C common port Contact capacity: 3A/AC250V, 1A/DC30V Note: up to 2.2kW only there is 1 channel RO
Others	Installation mode	Wall and rail installation of the inverters (single phase 230V/three phase 400V, <4kW) Wall-mounting, floor-mounting and flange-mounting of the inverters(three phase 400V, ≥4kW)
	Temperature of running environment	-10–50°C, derating is required if the ambient temperature exceeds 40°C
	Protection level	IP20
	Pollution level	Level 2
	Cooling mode	Air cooling
	DC reactor	Built-in DC reactor for 400V 18.5kW-110kW models Optional external DC reactor for 400V 132kW-400kW models
	Brake unit	Built-in brake unit for 37kW and below models; Optional built-in brake unit for 400V 45kW–55kW models; Optional external brake unit for 400V 75kW–400kW models;
	EMC filter	400V models(≥4kW) fulfill the requirements of IEC61800-3 C3 Optional external filter should meet the requirements of IEC61800-3 C2



### 3.4 Product nameplate

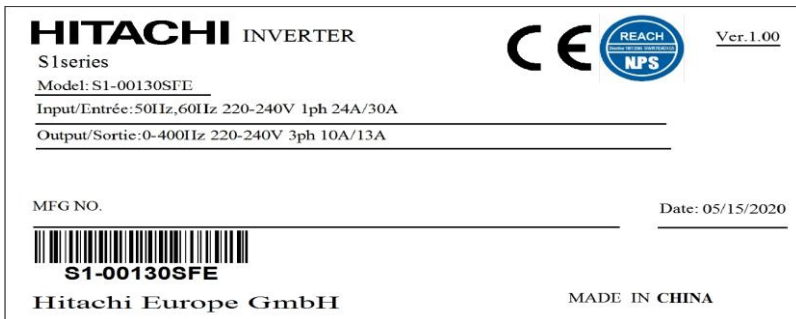

Fig 3.6 Product nameplate

### 3.5 Type designation key

The type designation key contains product information. Users can find the type designation key on the nameplate of the inverter.

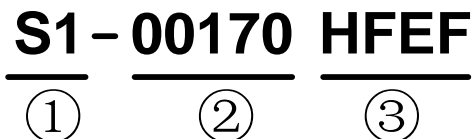

Fig 3.7 Type designation key

Field	Sign	Description	Contents
Abbreviation of product series	①	Abbreviation of product series	S1: standard inverter
Rated current	②	Rated output current in LD	00170: 17.0A continuous output current
Version	③	Version	H/S: H: AC 3PH 380V (-15%) – 440V (+ 10%) Rated voltage: 400V S: AC 1PH 220V (-15%) – 240V (+ 10%) Rated voltage: 230V F: built-in operator E: European version F: built-in EMC filter

### 3.6 Rated value

#### 3.6.1 AC 1PH 220V(-15%)-240V(+10%)

Inverter model	Power class (kW)	Input current (A)		Output current (A)	
		ND rating	LD rating	ND rating	LD rating
S1-00032SFE	0.4/0.75	6.5	7	2.5	3.2
S1-00055SFE	0.75/1.1	9.3	12	4.2	5.5
S1-00100SFE	1.5/2.2	15.7	24	7.5	10
S1-00130SFE	2.2/3	24	30	10	13

#### 3.6.2 AC 3PH 380V(-15%)–440V(+10%)

Inverter model	Power class (kW)	Input current (A)		Output current (A)	
		ND rating	LD rating	ND rating	LD rating
S1-00032HFE	0.75/1.1	3.4	4.7	2.5	3.2
S1-00055HFE	1.5/2.2	5.0	5.8	4.2	5.5
S1-00073HFE	2.2/3	5.8	10	5.5	7.3
S1-00125HFEF	4/5.5	13.5	19.5	9.5	12.5
S1-00170HFEF	5.5/7.5	19.5	23	14	17
S1-00230HFEF	7.5/11	25	30	18.5	23
S1-00320HFEF	11/15	32	40	25	32
S1-00380HFEF	15/18.5	40	47	32	38
S1-00450HFEF	18.5/22	47	51	38	45
S1-00600HFEF	22/30	51	70	45	60
S1-00750HFEF	30/37	70	80	60	75
S1-00920HFEF	37/45	80	98	75	92
S1-01150HFEF	45/55	98	128	92	115
S1-01500HFEF	55/75	128	139	115	150
S1-01700HFEF	75/90	139	168	150	170
S1-02150HFEF	90/110	168	201	180	215
S1-02600HFEF	110/132	201	265	215	260
S1-03050HFEF	132/160	265	310	260	305
S1-03400HFEF	160/185	310	345	305	340
S1-03800HFEF	185/200	345	385	340	380
S1-04250HFEF	200/220	385	430	380	425
S1-04800HFEF	220/250	430	460	425	480
S1-05300HFEF	250/280	460	500	480	530
S1-06000HFEF	280/315	500	580	530	600
S1-06500HFEF	315/355	580	625	600	650
S1-07200HFEF	355/400	625	715	650	720
S1-08600HFEF	400/500	715	890	720	860

### 3.7 Structure diagram

The inverter layout is shown in the figure below (take a 400V 30kW inverter as an example).

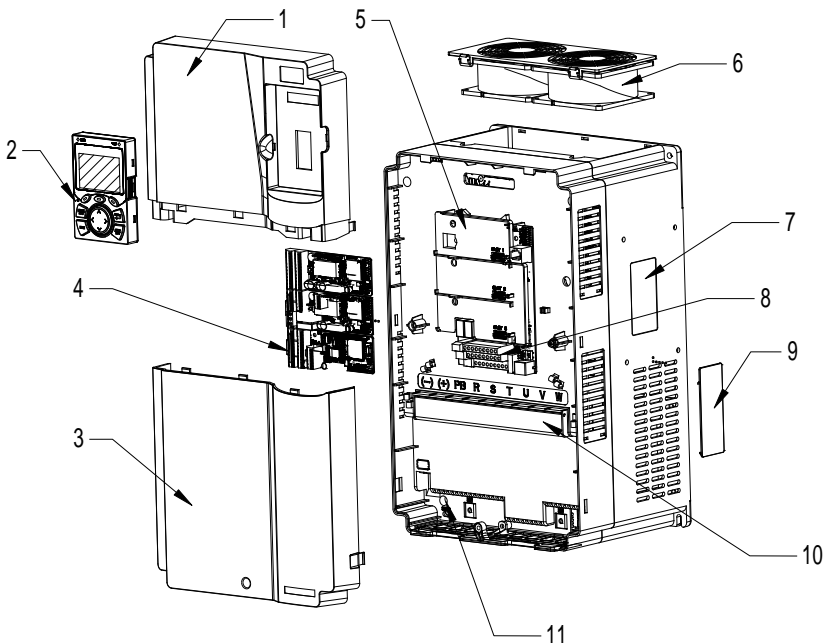



Fig 3.8 Structure diagram

No.	Name	Instruction
1	Upper cover	Protect internal components and parts
2	Keypad	See details at chapter 5.4 <i>Keypad operation</i>
3	Lower cover	Protect internal components and parts
4	Control terminals	See details at chapter 4 <i>Installation guide</i>
5	Baffle of control board	Protect the control board and install extension card
6	Cooling fan	See details at chapter 8 <i>Maintenance and hardware fault diagnosis</i>
7	Nameplate	See details at chapter 3.4 <i>Product nameplate</i>
8	Keypad interface	Connect the keypad
9	Cover plate of heat emission hole	Optional. Cover plate can upgrade protection level, however, as it will also increase internal temperature, derated use is required.
10	Main circuit terminal	See details at chapter 4 <i>Installation guide</i>
11	POWER indicator	Power indicator

## Chapter 4 Installation guide

### 4.1 What this chapter contains

This chapter introduces the mechanical and electrical installations of the inverter.

	<ul style="list-style-type: none"> <li>◇ Only well trained and qualified professionals are allowed to carry out the operations mentioned in this chapter. Please carry out operations according to instructions presented in Safety precautions. Ignoring these safety precautions may lead to physical injury or death, or device damage.</li> <li>◇ Ensure the inverter power is disconnected before installation. If the inverter has been powered on, disconnect the inverter and wait for at least the time designated on the inverter, and ensure the POWER indicator is off. Users are recommended to use a multimeter to check and ensure the inverter DC bus voltage is below 36V.</li> <li>◇ Installation must be designed and done according to applicable local laws and regulations. HITACHI does not assume any liability whatsoever for any installation which breaches local laws and regulations. If recommendations given by HITACHI are not followed, the inverter may experience problems that the warranty does not cover.</li> </ul>
---	--

### 4.2 Mechanical installation

#### 4.2.1 Installation environment

Installation environment is essential for the inverter to operate at its best in the long run. The installation environment of the inverter should meet the following requirements.

Environment	Condition
Installation site	Indoors
Ambient temperature	<ul style="list-style-type: none"> <li>◇ -10—+50°C;</li> <li>◇ When the ambient temperature exceeds 40°C, derate 1% for every additional 1°C;</li> <li>◇ It is not recommended to use the inverter when the ambient temperature is above 50°C;</li> <li>◇ In order to improve reliability, do not use the inverter in cases where the temperature changes rapidly;</li> <li>◇ When the inverter is used in a closed space eg control cabinet, use cooling fan or air conditioner to prevent internal temperature from exceeding the temperature required;</li> <li>◇ When the temperature is too low, if restart an inverter which has been idled for a long time, it is required to install external heating device before use to eliminate the freeze inside the inverter, failing to do so may cause damage to the inverter.</li> </ul>
Humidity	◇ The relative humidity (RH) of the air is less than 90%;

S1 series standard inverter

Environment	Condition
	<ul style="list-style-type: none"> <li>◇ Condensation is not allowed;</li> <li>◇ The max RH cannot exceed 60% in the environment where there are corrosive gases.</li> </ul>
Storage temperature	-30—+60°C
Running environment	<p>The installation site should meet the following requirements.</p> <ul style="list-style-type: none"> <li>◇ Away from electromagnetic radiation sources;</li> <li>◇ Away from oil mist, corrosive gases and combustible gases;</li> <li>◇ Ensure foreign object like metal powder, dust, oil and water will not fall into the inverter (do not install the inverter onto combustible object like wood);</li> <li>◇ Away from radioactive substance and combustible objects;</li> <li>◇ Away from harmful gases and liquids;</li> <li>◇ Low salt content;</li> <li>◇ No direct sunlight</li> </ul>
Altitude	<ul style="list-style-type: none"> <li>◇ Below 1000m;</li> <li>◇ When the altitude exceeds 1000m, derate 1% for every additional 100m;</li> <li>◇ When the altitude exceeds 2000m, configure isolation transformer on the input end of the inverter. It is recommended to keep the altitude below 5000m.</li> </ul>
Vibration	The max. amplitude of vibration should not exceed 5.8m/s <sup>2</sup> (0.6g)
Installation direction	Install the inverter vertically to ensure good heat dissipation effect

**Note:**

1. S1 series inverter should be installed in a clean and well-ventilated environment based on the IP level.
2. The cooling air must be clean enough and free from corrosive gases and conductive dust.

**4.2.2 Installation direction**

The inverter can be installed on the wall or in a cabinet.

The inverter must be installed vertically. Check the installation position according to following requirements. See Chapter 11 *Dimension drawings* for detailed outline dimensions.

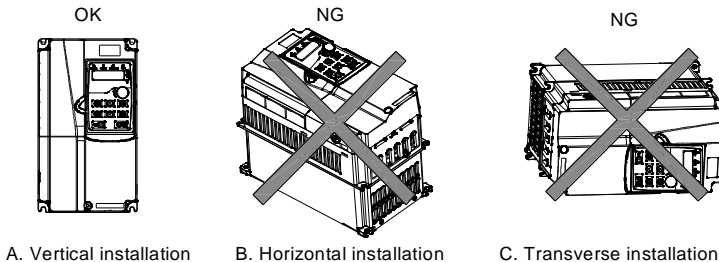

Fig 4.1 Installation direction of the inverter

### 4.2.3 Installation mode

There are four kinds of installation modes based on different inverter dimensions.

1. Rail-mounting: suitable for 230V and for 400V up to 2.2kW.
2. Wall-mounting: suitable for 400V up to 315kW.
3. Flange-mounting: suitable for 400V 4–200kW.
4. Floor-mounting: suitable for 400V 220–400kW.

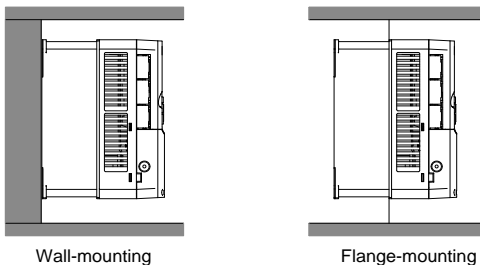

Fig 4.2 Installation mode

- (1) Mark the position of the installation hole;
- (2) Mount the screws or bolts onto the designated position;
- (3) Put the inverter on the wall;
- (4) Tighten the fixing screws on the wall.

**Note:**

1. Flange-mounting plate is a must for 400V 4–75kW inverters that adopt flange-mounting mode; while 400V 90–200kW models don't need.
2. Optional installation base is available for 400V 220–315kW. The base can hold an input AC reactor (or DC reactor) and an output AC reactor.

#### 4.2.4 Single-unit installation

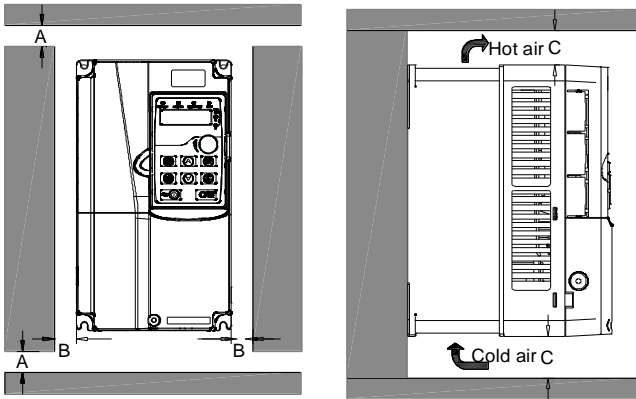

Fig 4.3 Single-unit installation

**Note:** The min. dimension of B and C is 100mm.

#### 4.2.5 Multiple-unit installation

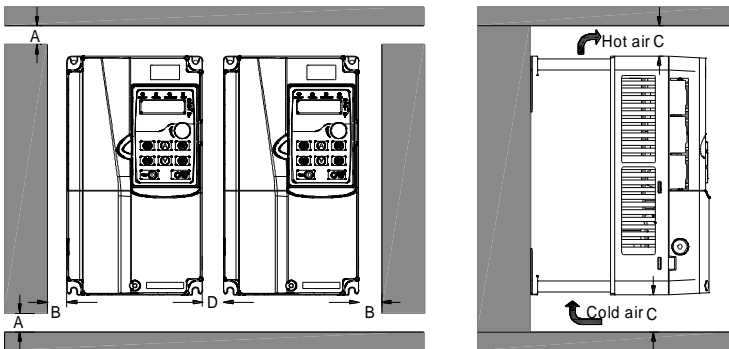

Fig 4.4 Parallel installation

**Note:**

1. When users install inverters in different sizes, align the top of each inverter before installation for the convenience of future maintenance.
2. The min. dimension of B, D and C is 100mm.

### 4.2.6 Vertical installation

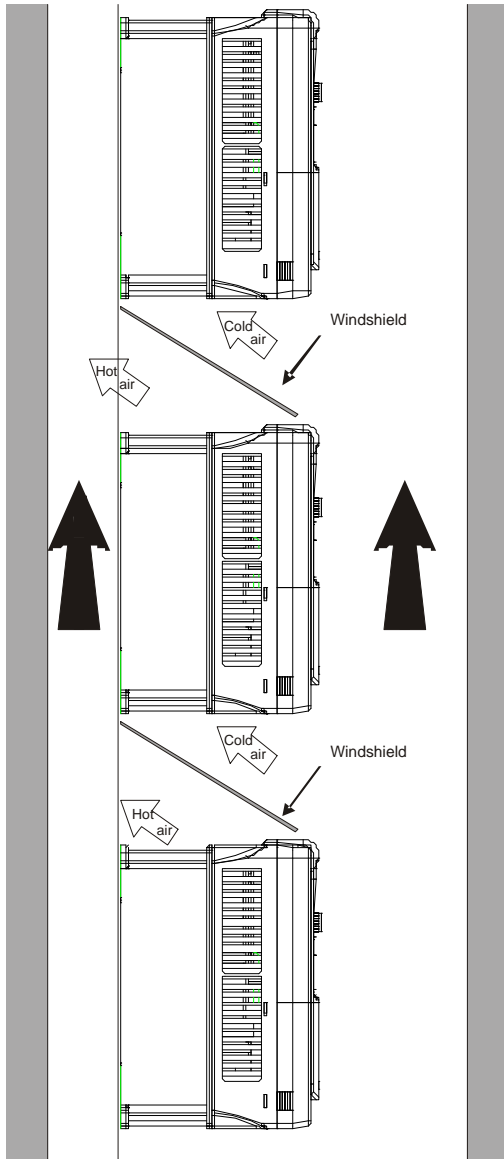

Fig 4.5 Vertical installation

**Note:** During vertical installation, users must install windshield, otherwise, the inverter will experience mutual interference, and the heat dissipation effect will be degraded.



### 4.2.7 Tilted installation

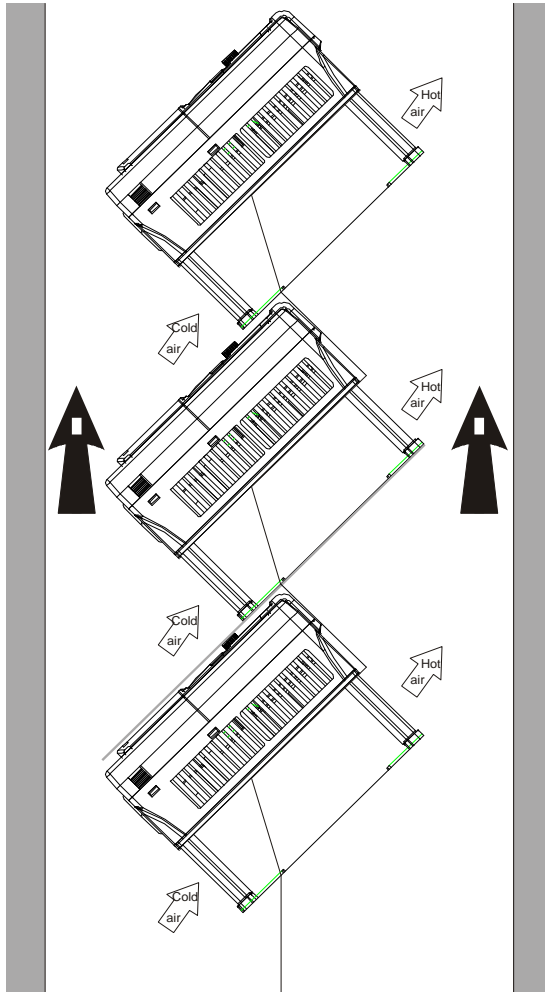

Fig 4.6 Tilted installation

**Note:** During tilted installation, it is a must to ensure the air inlet duct and air outlet duct are separated from each other to avoid mutual interference.

### 4.3 Standard wiring of main circuit

#### 4.3.1 Wiring diagram of main circuit

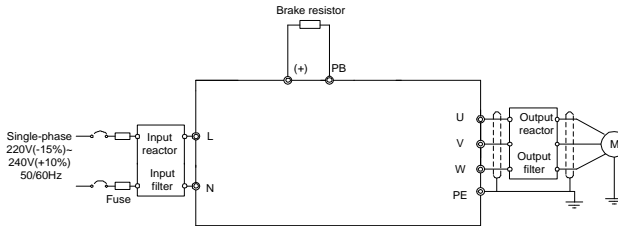

Fig 4.7 Main circuit wiring diagram of AC 1PH 220V(-15%)–240V(+10%)

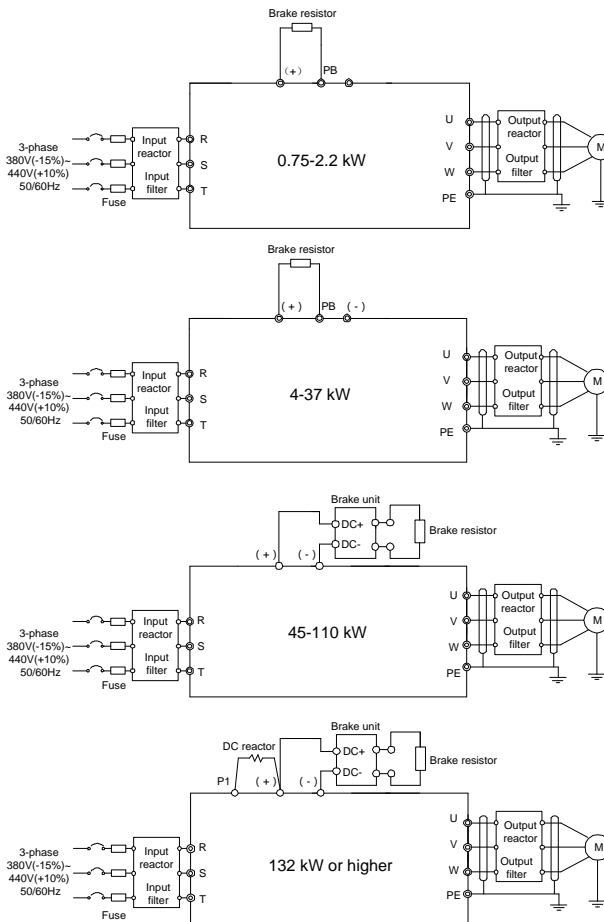

Fig 4.8 Main circuit wiring diagram of AC 3PH 380V(-15%)–440V(+10%)

**Note:**

1. The fuse, DC reactor, brake unit, brake resistor, input reactor, input filter, output reactor and output filter are optional parts. See Chapter 12 *Optional peripheral accessories* for details.
2. P1 and (+) have been short connected by default for 400V 132kW and above inverters. If users need to connect to external DC reactor, take off the short-contact tag of P1 and (+).
3. When connecting the brake resistor, take off the yellow warning sign marked with PB, (+) and (-) on the terminal block before connecting the brake resistor wire, otherwise, poor contact may occur.
4. 400V 45–55kW inverter can support both optional built-in brake unit and external brake unit.

**4.3.2 Main circuit terminal diagram**

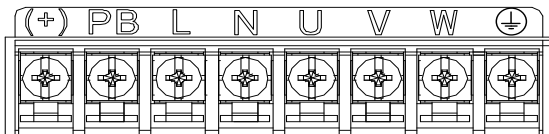

Fig 4.9 1PH 230V 0.4–2.2kW

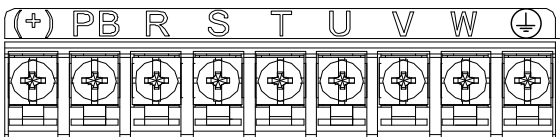

Fig 4.10 3PH 400V 0.75–2.2kW

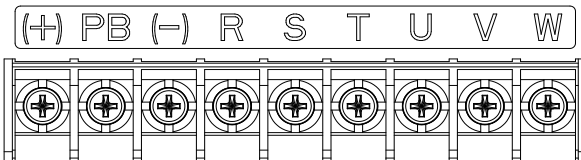

Fig 4.11 3PH 400V 4–22kW

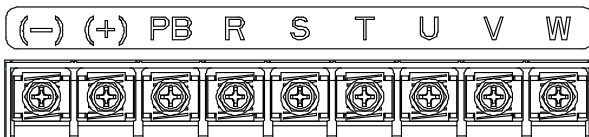

Fig 4.12 3PH 400V 30–37kW

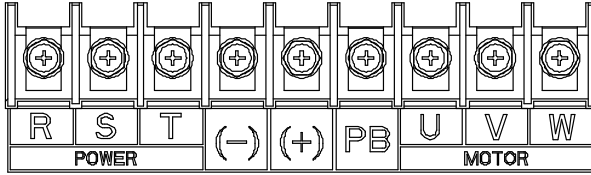

Fig 4.13 3PH 400V 45–110kW

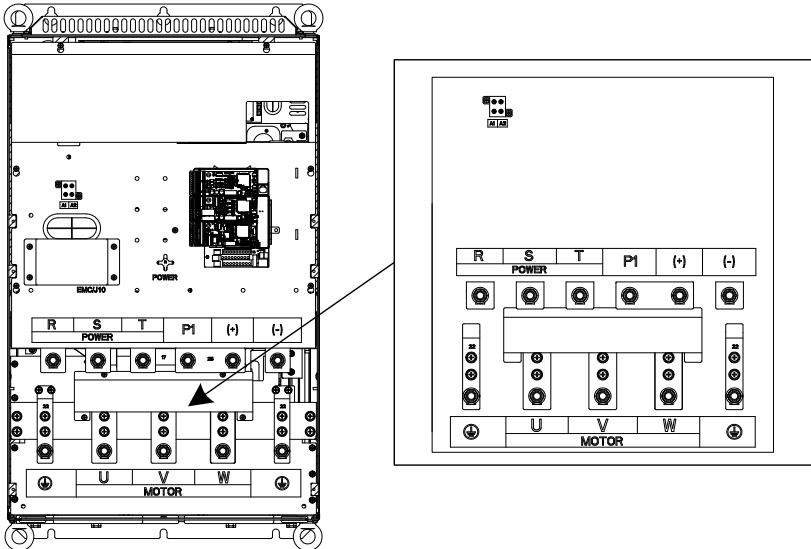

Fig 4.14 3PH 400V 132–200kW

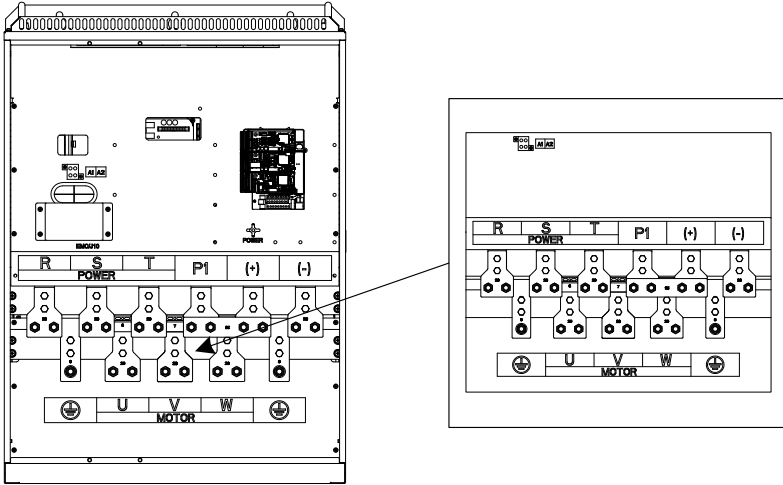

Fig 4.15 3PH 400V 220-315kW

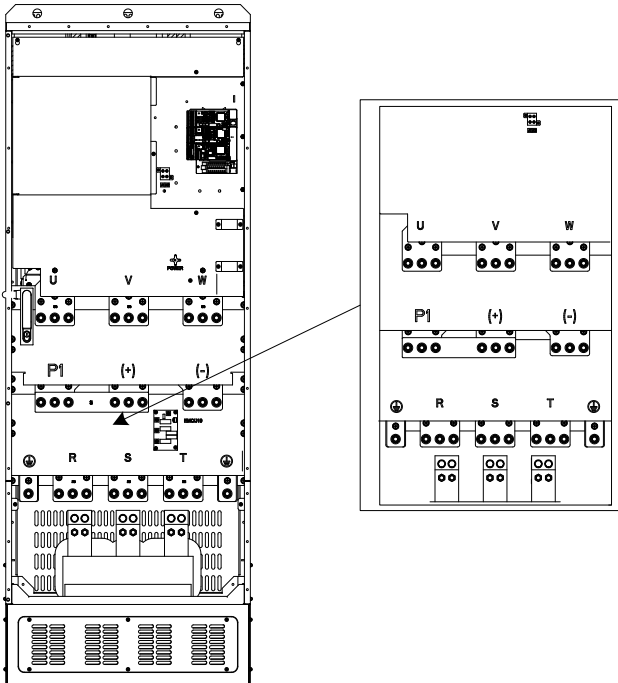

Fig 4.16 3PH 400V 355-400kW

S1 series standard inverter

Terminal sign	Terminal name				Function description
	230V 2.2kW and below	400V 37kW and below	400V 45-110kW	400V 132kW and above	
L, N	Main circuit power input	/			1PH AC input terminal, connect to the grid
R, S, T	/	Main circuit power input			3PH AC input terminal, connect to the grid
U, V, W	Inverter output				3PH AC output terminal, connect to the motor
P1	/	/	/	DC reactor terminal 1	P1 and (+) connect to external DC reactor terminal (+) and (-) connect to external brake unit terminal PB and (+) connect to external brake resistor terminal
(+)	Brake resistor terminal 1		Brake unit terminal 1	DC reactor terminal 2, Brake unit terminal 1	
(-)	/	Null	Brake unit terminal 2		
PB	Brake resistor terminal 2		/		
PE	Grounding resistor is less than 10 ohm				Grounding terminal for safe protection; each machine must carry two PE terminals and proper grounding is required

**Note:**

1. Do not use asymmetrical motor cable. If there is a symmetrical grounding conductor in the motor cable besides the conductive shielded layer, ground the grounding conductor on the inverter end and motor end.
2. Brake resistor, brake unit and DC reactor are optional parts.
3. Route the motor cable, input power cable and control cables separately.
4. "Null" means this terminal is not for external connection.
5. "/" means this terminal doesn't exist.

**4.3.3 Wiring process of the main circuit terminals**

1. Connect the grounding line of the input power cable to the grounding terminal (PE) of the inverter, and connect the power input cable to L, N (230V) or R, S and T (400V) terminals and tighten up.
2. Connect the grounding line of the motor cable to the grounding terminal of the inverter, and connect 3PH motor cable to U, V and W terminals and tighten up.
3. Connect the brake resistor which carries cables to the designated position.
4. Fix all the cables outside the inverter mechanically if allowed.

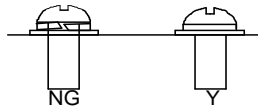

The screw is not fastened. The screw is fastened.  
 Fig 4.17 Screw installation diagram

## 4.4 Standard wiring of control circuit

### 4.4.1 Wiring diagram of basic control circuit

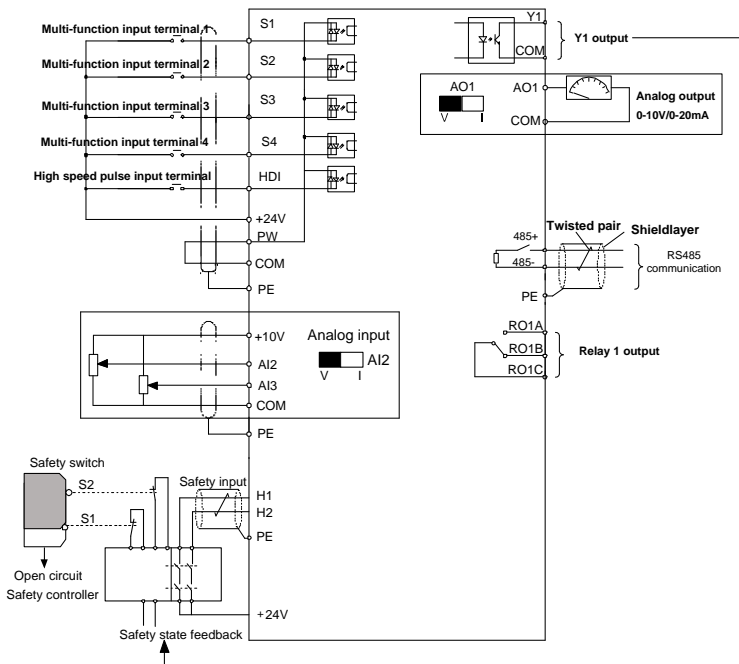

Fig 4.18 Wiring diagram of control circuit (0.4–2.2kW)

Terminal name	Technical specifications
485+	485 communication interface
485-	
S1	1. Internal impedance: 3.3kΩ 2. 12 – 30V voltage input is available 3. The terminal is the dual-direction input terminal 4. Max. Input frequency: 1kHz
S2	
S3	
S4	
HDI	Except for S1 – S4, this terminal can be used as high frequency input channel. Max. Input frequency: 50kHz Duty ratio: 30% – 70%
PW	Provide input digital working power from external to internal

S1 series standard inverter

Terminal name	Technical specifications
	Voltage range: 12–24V
Y1	1. Contact capacity: 50mA / 30V 2. Output frequency range: 0 – 1kHz
+24V-H1	1. Safe torque off (STO) redundant input, connect to external NC contact, STO acts when the contact opens, and the inverter stops output
+24V-H2	2. Safety input signal wires use shielded wire whose length is within 25m
+ 24V	The inverter provides user power; the maximum output current is 200mA
COM	Common port of + 24V
+ 10V	10V reference power supply Max. Output current: 50mA
AI2	1. Input range: AI2 voltage and current can be chosen: 0 – 10V / 0 – 20mA; AI3: -10V – + 10V
AI3	2. Input impedance: voltage input: 20kΩ; current input: 500Ω 3. Voltage or current input can be set by toggle switch 4. Resolution: the minimum AI2 / AI3 is 10mV / 20mV when 10V corresponds to 50Hz
GND	Analog reference ground
AO1	1. Output range: 0 – 10V voltage or 0 – 20mA current 2. Voltage or current output is set by toggle switch 3. Error $\pm 1\%$ , 25 ° C
RO1A	1. Contact capacity: 3A / AC250V, 1A / DC30V
RO1B	2. Please note that it should not be used as high frequency switch output
RO1C	



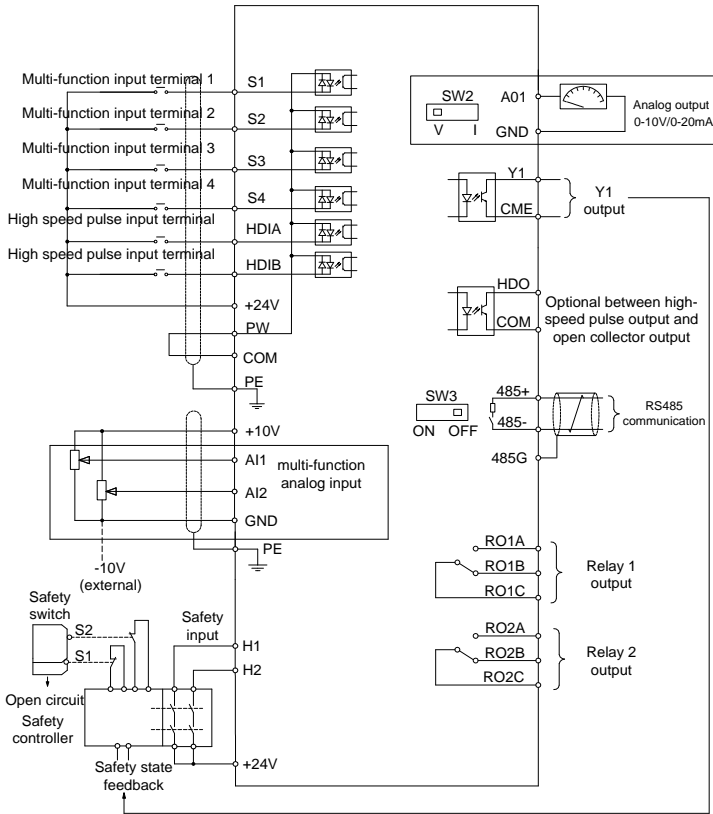

Fig 4.19 Wiring diagram of control circuit (4-400kW)

Terminal name	Technical specification
+ 10V	10V reference power supply
AI1	1. Input range: AI1 voltage / current can choose 0–10V / 0–20mA
AI2	AI2: -10V – +10V voltage 2. Input impedance: 20kΩ during voltage input; 250Ω during current input 3. Voltage or current input can be set by parameters 4. Resolution ratio: When 10V corresponds to 50Hz, the Min. Resolution ratio is 5mV 5. 25 ° C, When input above 5V or 10mA, the error is ± 0.5%
GND	Analog reference ground
AO1	1. Output range: 0–10V voltage or 0–20mA current 2. Voltage or current output is set by toggle switch SW2 3. 25° C, when input above 5V or 10mA, the error is ± 0.5%
RO1A	RO1 relay output; RO1A is NO, RO1B is NC, RO1C is common port

S1 series standard inverter

Terminal name	Technical specification	
RO1B	Contact capacity: 3A / AC250V, 1A / DC30V	
RO1C		
RO2A	RO2 relay output; RO2A is NO, RO2B is NC, RO2C is common port Contact capacity: 3A / AC250V, 1A / DC30V	
RO2B		
RO2C		
HDO	1. Switch capacity: 50mA / 30V 2. Range of output frequency: 0–50kHz 3. Duty ratio: 50%	
COM	Common port of + 24V	
CME	Common port of open collector output	
Y1	1. Switch capacity: 50mA / 30V 2. Range of output frequency: 0–1kHz	
485+	485 communication interface	
485-		
PE	Grounding terminal	
PW	Provide input digital working power from external to internal Voltage range: 12–24V	
24V	The inverter provides user power; the maximum output current is 200mA	
COM	Common port of + 24V	
S1	Digital input 1	1. Internal impedance: 3.3kΩ 2. Accept 12–30V voltage input 3. This terminal is bi-directional input terminal and supports NPN / PNP connection modes 4. Max. Input frequency: 1kHz 5. All are programmable digital input terminals, users can set the terminal function via function codes
S2	Digital input 2	
S3	Digital input 3	
S4	Digital input 4	
HDIA	Besides S1–S4 functions, it can also act as high frequency pulse input channel	
HDIB	Max. Input frequency: 50kHz Duty ratio: 30% –70%	
+24V–H1	STO input 1	1. Safe torque off (STO) redundant input, connect to external NC contact, STO acts when the contact opens, and the inverter stops output 2. Safety input signal wires use shielded wire whose length is within 25m
+24V–H2	STO input 2	

#### 4.4.2 Input/output signal connection diagram

Set NPN /PNP mode and internal/external power via U-type short-contact tag. PNP internal mode is adopted by default.

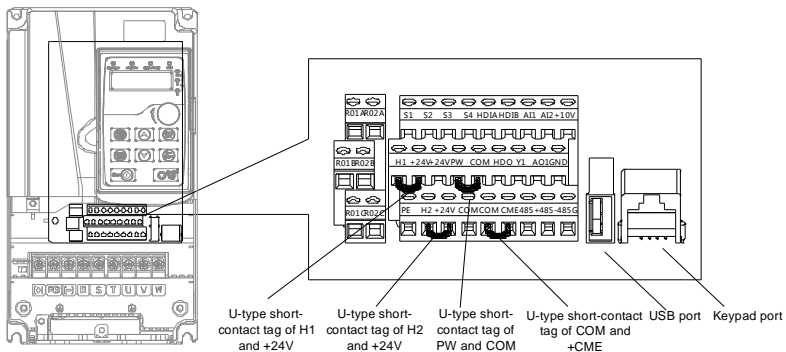

Fig 4.20 Position of U-type short-contact tag

Note: As shown in Fig 4.19, the USB port can be used to upgrade the software, and the keypad port can be used to connect an external keypad. The external keypad cannot be used when the keypad of the inverter is used.

If input signal comes from NPN transistors, set the U-type short-contact tag based on the power used according to the figure below.

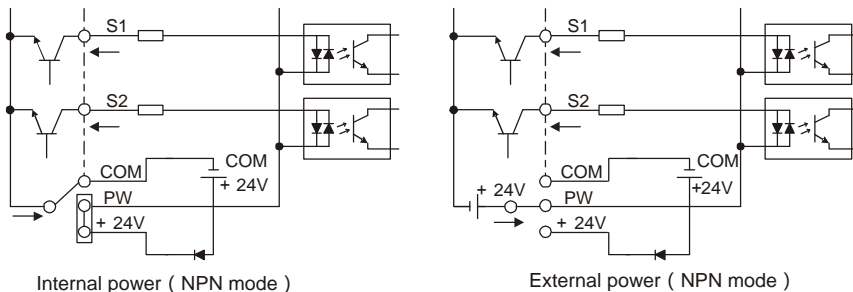

Fig 4.21 NPN mode

If input signal comes from PNP transistor, set the U-type short-contact tag based on the power used according to the figure below.

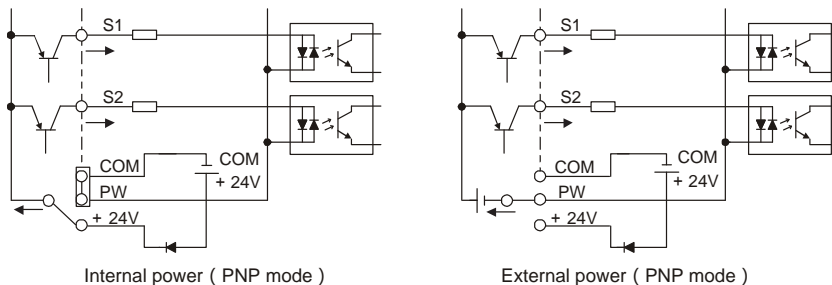

Fig 4.22 PNP mode

### 4.5 Wiring protection

#### 4.5.1 Protect the inverter and input power cable in short-circuit

Protect the inverter and input power cable during short-circuit to avoid thermal overload.

Carry out protective measures according to the following requirements.

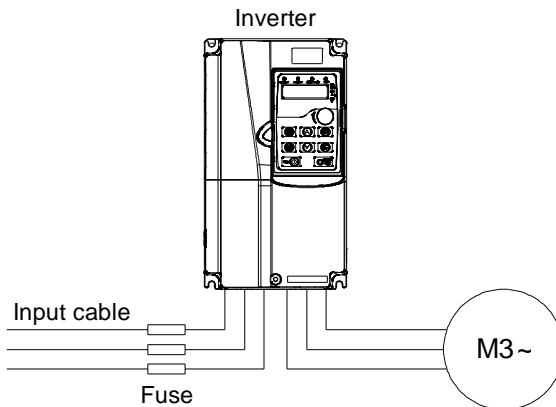

Fig 4.23 Fuse configuration

**Note:** Select the fuse according to operation manual. During short-circuit, the fuse will protect input power cables to avoid damage to the inverter; when internal short-circuit occurred to the inverter, it can protect neighboring equipment from being damaged.

#### 4.5.2 Protect the motor and motor cable in short circuit

If the motor cable is selected based on rated inverter current, the inverter will be able to protect the motor cable and motor during short circuit without other protective devices.



◇ If the inverter is connected to multiple motors, it is a must to use a separated thermal overload switch or breaker to protect the cable and motor, which may require the fuse to cut off the short circuit current.

#### 4.5.3 Protect motor and prevent thermal overload

According to the requirements, the motor must be protected to prevent thermal overload. Once

overload is detected, users must cut off the current. The inverter is equipped with motor thermal overload protection function, which will block output and cut off the current (if necessary) to protect the motor.

#### 4.5.4 Bypass connection

In some critical occasions, industrial frequency conversion circuit is necessary to ensure proper operation of the system when inverter fault occurs.

In some special cases, eg, only soft startup is needed, it will convert to power-frequency operation directly after soft startup, corresponding bypass link is also needed.



⚡ Do not connect any power source to inverter output terminals U, V and W. The voltage applied to motor cable may cause permanent damage to the inverter.

If frequent switch-over is needed, users can use the switch which carries mechanical interlock or a contactor to ensure motor terminals will not be connected to input power cables and inverter output ends simultaneously.

## Chapter 5 Basic operation instructions

### 5.1 What this chapter contains

This chapter tells users how to use the inverter keypad and the commissioning procedures for common functions of the inverter.

### 5.2 Keypad introduction

LED keypad is included in the standard configuration of S1 series inverter. Users can control the inverter start/stop, read state data and set parameters via keypad.

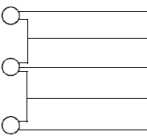









Fig 5.1 External Keypad (up to 2.2kW)



Fig 5.2 Keypad (4-400kW)

S1 series standard inverter

No.	Name	Description					
1	State LED	<b>RUN/TUNE</b>	LED off means that the inverter is in the stopping state; LED blinking means the inverter is in the parameter autotune state; LED on means the inverter is in the running state.				
		<b>FWD/REV</b>	FED/REV LED LED off means the inverter is in the forward rotation state; LED on means the inverter is in the reverse rotation state				
		<b>LOCAL/REMOT</b>	LED for keypad operation, terminals operation and remote communication control LED off means that the inverter is in the keypad operation state; LED blinking means the inverter is in the terminals operation state; LED on means the inverter is in the remote communication control state.				
		<b>TRIP</b>	LED for faults LED on when the inverter is in the fault state; LED off in normal state; LED blinking means the inverter is in the pre-alarm state.				
2	Unit LED	Mean the unit displayed currently					
			Hz	Frequency unit			
			RPM	Rotating speed unit			
			A	Current unit			
			%	Percentage			
V	Voltage unit						
3	Code displaying zone	5-figure LED display displays various monitoring data and alarm code such as set frequency and output frequency.					
		<b>Display</b>	<b>Means</b>	<b>Display</b>	<b>Means</b>	<b>Display</b>	<b>Means</b>
		0	0	1	1	2	2
		3	3	4	4	5	5
		6	6	7	7	8	8
		9	9	A	A	b	b
		C	C	d	d	E	E
		F	F	H	H	l	l
		L	L	N	N	n	n
		o	o	P	P	r	r
		S	S	t	t	U	U
		v	v	.	.	-	-

No.	Name	Description		
4	potentiometer	For models up to 2.2kW, it's AI1(analog protentionmeter); For modes >2.2kW, it's digital potentiometer;		
5	Buttons		Programming key	Enter or escape from the first level menu and remove the parameter quickly
			Entry key	Enter the menu step-by-step Confirm parameters
			UP key	Increase data or function code progressively
			DOWN key	Decrease data or function code progressively
			Right-shift key	Move right to select the displaying parameter circularly in stopping and running mode. Select the parameter modifying digit during the parameter modification
			Run key	This key is used to operate on the inverter in key operation mode
			Stop/Reset key	This key is used to stop in running state and it is limited by function code P07.04 This key is used to reset all control modes in the fault alarm state
			Quick key	The function of this key is confirmed by function code P07.02.

### 5.3 Keypad display

The display state of S1 series keypad is divided into stop parameter display state, running parameter display state and fault alarm display state.

#### 5.3.1 Displayed state of stopping parameter

When the inverter is in the stopping state, the keypad will display stopping parameters which is shown in figure 5.3.

In the stopping state, various kinds of parameters can be displayed. Select the parameters to be displayed or not by P07.07. See the instructions of P07.07 for the detailed definition of each bit.

In the stopping state, there are 14 stopping parameters can be selected to be displayed or not. They are: set frequency, bus voltage, input terminals state, output terminals state, PID given value, PID feedback value, torque set value, AI1, AI2, AI3, HDI, PLC and the current stage of multi-step speeds, pulse counting value, length value. P07.07 can select the parameter to be displayed or not by bit and **[SHIFT]** can shift the parameters from left to right, **[QUICK/JOG]**(P07.02=2) can shift the parameters from right to left.

#### 5.3.2 Displayed state of running parameters

After the inverter receives valid running commands, the inverter will enter into the running state and



the keypad will display the running parameters. **RUN/TUNE** LED on the keypad is on, while the **FWD/REV** is determined by the current running direction which is shown as figure 5-2.

In the running state, there are 24 parameters can be selected to be displayed or not. They are: running frequency, set frequency, bus voltage, output voltage, output torque, PID given value, PID feedback value, input terminals state, output terminals state, torque set value, length value, PLC and the current stage of multi-step speeds, pulse counting value, AI1, AI2, AI3, HDI, percentage of motor overload, percentage of inverter overload, ramp given value, linear speed, AC input current. P07.05 and P07.06 can select the parameter to be displayed or not by bit and **»/SHIFT** can shift the parameters from left to right, **QUICK/JOG**(P07.02=2) can shift the parameters from right to left.

### 5.3.3 Displayed state of fault

If the inverter detects the fault signal, it will enter into the fault pre-alarm displaying state. The keypad will display the fault code by flicking. The **TRIP** LED on the keypad is on, and the fault reset can be operated by the **STOP/RST** on the keypad, control terminals or communication commands.

### 5.3.4 Displayed state of function codes editing

In the state of stopping, running or fault, press **PRG/ESC** to enter into the editing state (if there is a password, see P07.00 ).The editing state is displayed on two classes of menu, and the order is: function code group/function code number→function code parameter, press **DATA/ENT** into the displayed state of function parameter. On this state, you can press **DATA/ENT** to save the parameters or press **PRG/ESC** to retreat.

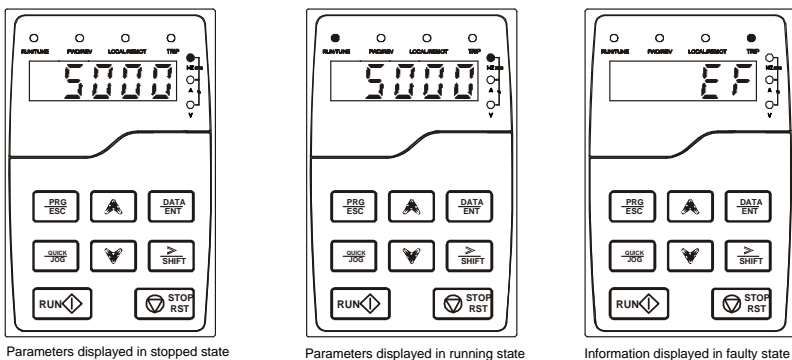

Fig 5.3 Displayed state

## 5.4 Keypad operation

Operate the inverter via operation panel. See the detailed structure description of function codes in the brief diagram of function codes.

### 5.4.1 How to modify the function codes of the inverter

The inverter has three levels menu, which are:

1. Group number of function code (first-level menu)
2. Tab of function code (second-level menu)
3. Set value of function code (third-level menu)

Remarks: Press both the **PRG/ESC** and the **DATA/ENT** can return to the second-level menu from the third-level menu. The difference is: pressing **DATA/ENT** will save the set parameters into the control panel, and then return to the second-level menu with shifting to the next function code automatically; while pressing **PRG/ESC** will directly return to the second-level menu without saving the parameters, and keep staying at the current function code.

Under the third-level menu, if the parameter has no flickering bit, it means the function code cannot be modified. The possible reasons could be:

- 1) This function code is not modifiable parameter, such as actual detected parameter, operation records and so on;
- 2) This function code is not modifiable in running state, but modifiable in stop state.

Example: Set function code P00.01 = 1.

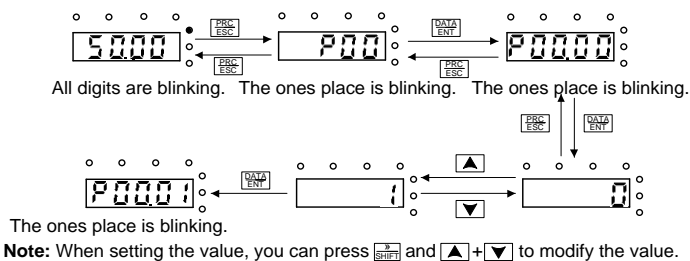

Fig 5.4 Sketch map of modifying parameters

#### 5.4.2 How to set the password of the inverter

S1 series inverters provide password protection function to users. Set P7.00 to gain the password and the password protection becomes valid instantly after quitting from the function code editing state. Press **PRG/ESC** again to the function code editing state, "0.0.0.0.0" will be displayed. Unless using the correct password, the operators cannot enter it.

Set P7.00 to 0 to cancel password protection function.

The password protection becomes effective instantly after retreating from the function code editing state. Press **PRG/ESC** again to the function code editing state, "0.0.0.0.0" will be displayed. Unless using the correct password, the operators cannot enter it.

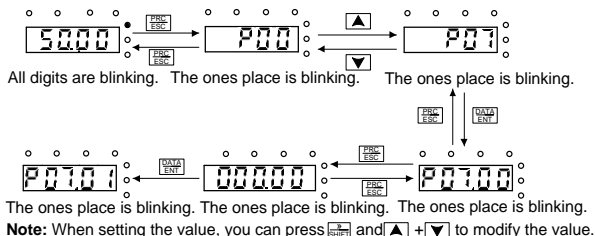
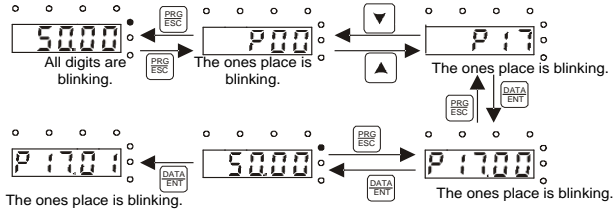

Fig 5.5 Sketch map of password setting

### 5.4.3 How to watch the inverter state through function codes

S1 series inverters provide group P17 as the state inspection group. Users can enter into P17 directly to watch the state.



**Note:** When setting the value, you can press **PRG/ESC** and **↑**+**↓** to modify the value.

Fig 5.6 Sketch map of state watching

## 5.5 Basic operation instruction

### 5.5.1 What this section contains

This section introduces the function modules inside the inverter

	<ul style="list-style-type: none"> <li>◇ Ensure all the terminals are fixed and tightened firmly.</li> <li>◇ Ensure the motor matches with the inverter power.</li> </ul>
--	---

### 5.5.2 Common commissioning procedures

The common operation procedures are shown below (take motor 1 as an example).

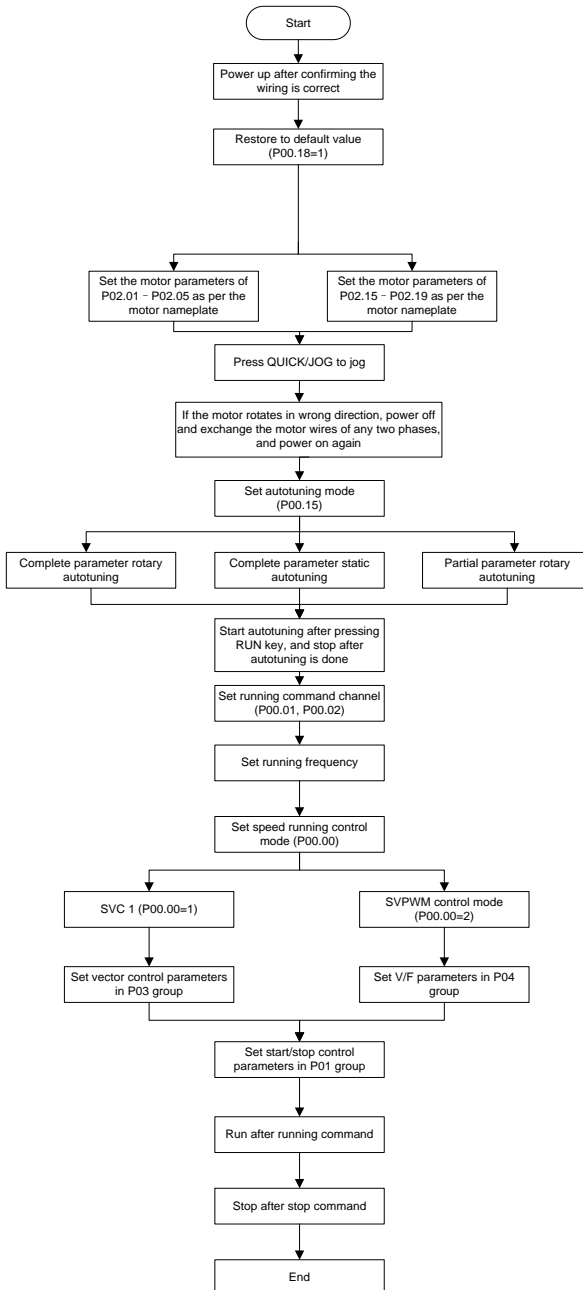

**Note:** If fault occurred, rule out the fault cause according to "fault tracking".

The running command channel can be set by terminal commands besides P00.01.

Current running command channel P00.01	Multi-function terminal function (36) Command switches to keypad	Multi-function terminal function (37) Command switches to terminal	Multi-function terminal function (38) Command switches to communication
Keypad	/	Terminal	Communication
Terminal	Keypad	/	Communication
Communication	Keypad	Terminal	/

**Note: "/" means this multi-function terminal is valid under current reference channel.**

Related parameter list:

Function code	Name	Detailed parameter description	Default value
P00.00	Speed control mode	1: SVC 1 2: V/F <b>Note: If 1 is selected, it is required to carry out motor parameter autotuning first.</b>	2
P00.01	Running command channel	0: Keypad 1: Terminal 2: Communication	1
P00.02	Reserved	Reserved	0
P00.15	Motor parameter autotuning	0: No operation 1: Rotary autotuning; carry out comprehensive motor parameter autotuning; rotary autotuning is used in cases where high control precision is required; 2: Static autotuning 1 (comprehensive autotuning); static autotuning 1 is used in cases where the motor cannot be disconnected from load; 3: Static autotuning 2 (partial autotuning) ; when current motor is motor 1, only P02.06, P02.07 and P02.08 will be autotuned; when current motor is motor 2, only P12.06, P12.07 and P12.08 will be autotuned.	0
P00.18	Function parameter restoration	0: No operation 1: Restore to default value 2: Clear fault history <b>Note: After the selected function</b>	0

S1 series standard inverter

Function code	Name	Detailed parameter description	Default value
		<b>operations are done, this function code will be restored to 0 automatically. Restoration to default value will clear the user password, this function should be used with caution.</b>	
P02.01	Rated power of asynchronous motor 1	0.1–3000.0kW	Depend on model
P02.02	Rated frequency of asynchronous motor 1	0.01Hz–P00.03 (Max. output frequency)	50.00Hz
P02.03	Rated speed of asynchronous motor 1	1–36000rpm	Depend on model
P02.04	Rated voltage of asynchronous motor 1	0–1200V	Depend on model
P02.05	Rated current of asynchronous motor 1	0.8–6000.0A	Depend on model
P05.01– P05.06	Function of multi-function digital input terminal (S1–S4, HDIA, HDIB)	36: Command switches to keypad 37: Command switches to terminal 38: Command switches to communication	/
P07.01	Parameter copy	0: No operation 1: Upload the local function parameter to the keypad 2: Download the keypad function parameter to local address (including the motor parameters) 3: Download the keypad function parameter to local address (excluding the motor parameter of P02 and P12 group) 4: Download the keypad function parameters to local address (only for the motor parameter of P02 and P12 group) <b>Note:</b> After finish 1 – 4, the parameter will restore to 0 and the uploading and downloading does not include P29.	0
P07.02	<u>QUICK/JOG</u> key function	Range: 0x00–0x27 Ones: <u>QUICK/JOG</u> key function selection 0: No function 1: Jogging 2: Reserved 3: Switching between forward/reverse rotation 4: Clear <u>UP/DOWN</u> setting 5: Coast to stop	0x01

Function code	Name	Detailed parameter description	Default value
		6: Switch running command reference mode by sequence 7: Reserved Tens: Reserved	

### 5.5.3 Vector control

Asynchronous motors are featured with high order, non-linear, strong coupling and multi-variables, which makes it very difficult to control asynchronous motors during actual application. The vector control theory aims to solve this problem through measuring and controlling the stator current vector of asynchronous motor, and decomposing the stator current vector into exciting current (current component which generates internal magnet field) and torque current (current component which generates torque) based on field orientation principle, and then controlling the amplitude value and phase position of these two components (namely, control the stator current vector of motor) to realize decoupling control of exciting current and torque current, thus achieving high-performance speed regulation of asynchronous motor.

S1 series inverter carries built-in speed sensor-less vector control algorithm. As the core algorithm of vector control is based on accurate motor parameter model, the accuracy of motor parameters will impact the control performance of vector control. It is recommended to input accurate motor parameters and carry out motor parameter autotuning before vector operation.

As vector control algorithm is complicated, users should be cautious of regulation on dedicated function parameters of vector control.

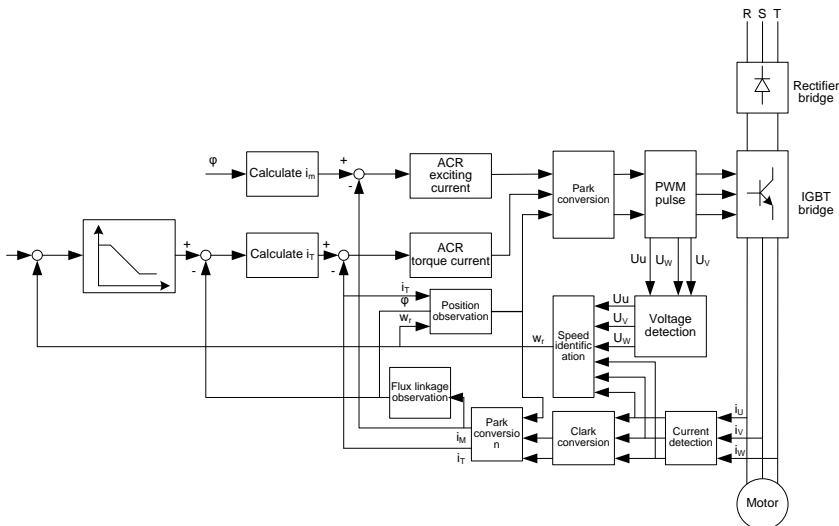

S1 series standard inverter

Function code	Name	Detailed parameter description	Default value
P00.00	Speed control mode	1: SVC 1 2: V/F <b>Note: If 1 is selected, it is required to carry out motor parameter autotuning first.</b>	2
P00.15	Motor parameter autotuning	0: No operation 1: Rotary autotuning; carry out comprehensive motor parameter autotuning; rotary autotuning is used in cases where high control precision is required; 2: Static autotuning 1 (comprehensive autotuning); static autotuning 1 is used in cases where the motor cannot be disconnected from load; 3: Static autotuning 2 (partial autotuning) ; when current motor is motor 1, only P02.06, P02.07 and P02.08 will be autotuned; when current motor is motor 2, only P12.06, P12.07 and P12.08 will be autotuned.	0
P03.00	Speed loop proportional gain 1	0–200.0	20.0
P03.01	Speed loop integral time 1	0.000–10.000s	0.200s
P03.02	Switching low point frequency	0.00Hz–P03.05	5.00Hz
P03.03	Speed loop proportional gain 2	0–200.0	20.0
P03.04	Speed loop integral time 2	0.000–10.000s	0.200s
P03.05	Switching high point frequency	P03.02–P00.03 (Max. output frequency)	10.00Hz
P03.06	Speed loop output filter	0–8 (corresponds to $0-2^8/10$ ms)	0
P03.07	Electromotion slip compensation coefficient of vector control	50%–200%	100%
P03.08	Brake slip compensation coefficient of vector control	50%–200%	100%
P03.09	Current loop proportional	0–65535	1000



S1 series standard inverter

Function code	Name	Detailed parameter description	Default value
	coefficient P		
P03.10	Current loop integral coefficient I	0-65535	1000
P03.11	Torque setup mode selection	1: Set via keypad (P03.12) 2: Set via AI1 3: Set via AI2 4: Set via AI3 5: Set via pulse frequency HDI/HDIA 6: Set via multi-step torque 7: Set via Modbus communication 8 – 12: Reserved Note: Set mode 2-7, 100% corresponds to three times of rated motor current.	1
P03.12	Torque set by keypad	-300.0%~300.0% (rated motor current)	50.0%
P03.13	Torque reference filter time	0.000-10.000s	0.010s
P03.14	Source of upper limit frequency setup of forward rotation in torque control	0: Keypad (P03.16) 1: AI1 2: AI2 3: AI3 4: Pulse frequency HDI/HDIA 5: Multi-step 6: Modbus communication 7 - 12: Reserved Note: Source 1-6, 100% relative to the max. frequency	0
P03.15	Source of upper limit frequency setup of reverse rotation in torque control	0: Keypad (P03.17) 1-11: the same as P03.14	0
P03.16	Keypad limit value of upper limit frequency of forward rotation in torque control	Value range: 0.00 Hz-P00.03 (Max. output frequency)	50.00Hz
P03.17	Keypad limit value of upper limit frequency of reverse rotation in torque control		50.00Hz
P03.18	Source of upper limit setup of the torque when motoring	0: Keypad (P03.20) 1: AI1 2: AI2 3: AI3 4: Pulse frequency HDI/HDIA	0

Function code	Name	Detailed parameter description	Default value
		5: Modbus communication 6 - 11: Reserved Note: Source 1–5, 100% relative to three times of motor current.	
P03.19	Source of upper limit setup of brake torque	0: Keypad (P03.21) 1–10: the same as P03.18	0
P03.20	Set upper limit of the torque when motoring via keypad	0.0–300.0% (rated motor current)	180.0%
P03.21	Set upper limit of brake torque via keypad		180.0%
P03.22	Flux-weakening coefficient in constant power area	0.1–2.0	0.3
P03.23	Min. flux-weakening point in constant power area	10%–100%	20%
P03.24	Max. voltage limit	0.0–120.0%	100.0%
P03.25	Pre-exciting time	0.000–10.000s	0.300s
P17.32	Flux linkage	0.0–200.0%	0.0%

#### 5.5.4 V/F control mode

S1 inverter also carries built-in V/F control function. V/F mode can be used in cases where mediocre control precision is enough. In cases where an inverter needs to drive multiple motors, it is also recommended to adopt V/F control mode.

S1 inverter provides multiple kinds of V/F curve modes to meet different field needs. Users can select corresponding V/F curve or set the V/F curve as needed.

#### Suggestions:

1. For the load featuring constant moment, eg, conveyor belt which runs in straight line, as the moment should be constant during the whole running process, it is recommended to adopt straight-type V/F curve.
2. For the load featuring decreasing moment, eg, fan and water pump, as the relation between its actual torque and speed is squared or cubed, it is recommended to adopt the V/F curve corresponds to power 1.3, 1.7 or 2.0.

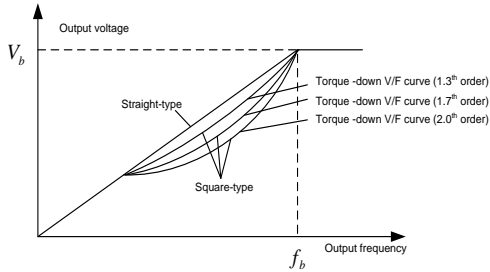

S1 inverter also provides multi-point V/F curve. Users can alter the V/F curve outputted by inverter through setting the voltage and frequency of the three points in the middle. The whole curve consists of five points starting from (0Hz, 0V) and ending in (fundamental motor frequency, rated motor voltage). During setup, it is required that  $0 \leq f_1 \leq f_2 \leq f_3 \leq \text{fundamental motor frequency}$ , and  $0 \leq V_1 \leq V_2 \leq V_3 \leq \text{rated motor voltage}$

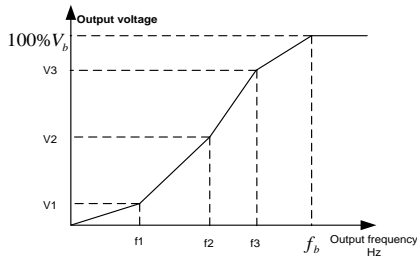

S1 inverter provides dedicated function codes for V/F control mode. Users can improve the performance of V/F through settings.

1. Torque boost

Torque boost function can effectively compensate for the low-speed torque performance during V/F control. Automatic torque boost has been set by default to enable the inverter to adjust the torque boost value based on actual load conditions.

**Note:**

- (1) Torque boost is effective only under torque boost cut-off frequency;
- (2) If the torque boost is too large, low-frequency vibration or overcurrent may occur to the motor, if such situation occurs, lower the torque boost value.

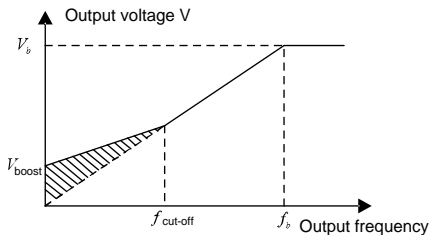

2. Energy-saving run

During actual running, the inverter can search for the max. efficiency point to keep running in the most efficient state to save energy.

**Note:**

- (1) This function is generally used in light load or no-load cases.
- (2) This function does for fit in cases where load transient is required.

3. V/F slip compensation gain

V/F control belongs to open-loop mode, which will cause motor speed to fluctuate when motor load transients. In cases where strict speed requirement is needed, users can set the slip compensation gain to compensate for the speed variation caused by load fluctuation through internal output adjustment of inverter.

**The set range of slip compensation gain is 0–200%, in which 100% corresponds to rated slip frequency.**

**Note:** Rated slip frequency= (rated synchronous speed of motor-rated speed of motor) x number of motor pole pairs/60

4. Oscillation control

Motor oscillation often occurs in V/F control in large-power drive applications. To solve this problem, S1 series inverter sets two function codes to control the oscillation factor, and users can set the corresponding function code based on the occurrence frequency of oscillation.

**Note:** The larger the set value, the better the control effect, however, if the set value is too large, it may easily lead to too large inverter output current.

5. Asynchronous motor IF control

The IF control described in this manual is only involved with asynchronous motors. IF control is implemented by performing closed-loop control on the total output current of the inverter. The output voltage adapts to the current reference, and open-loop control is separately performed over the frequency of the voltage and current.

Customized V/F curve (V/F separation) function:

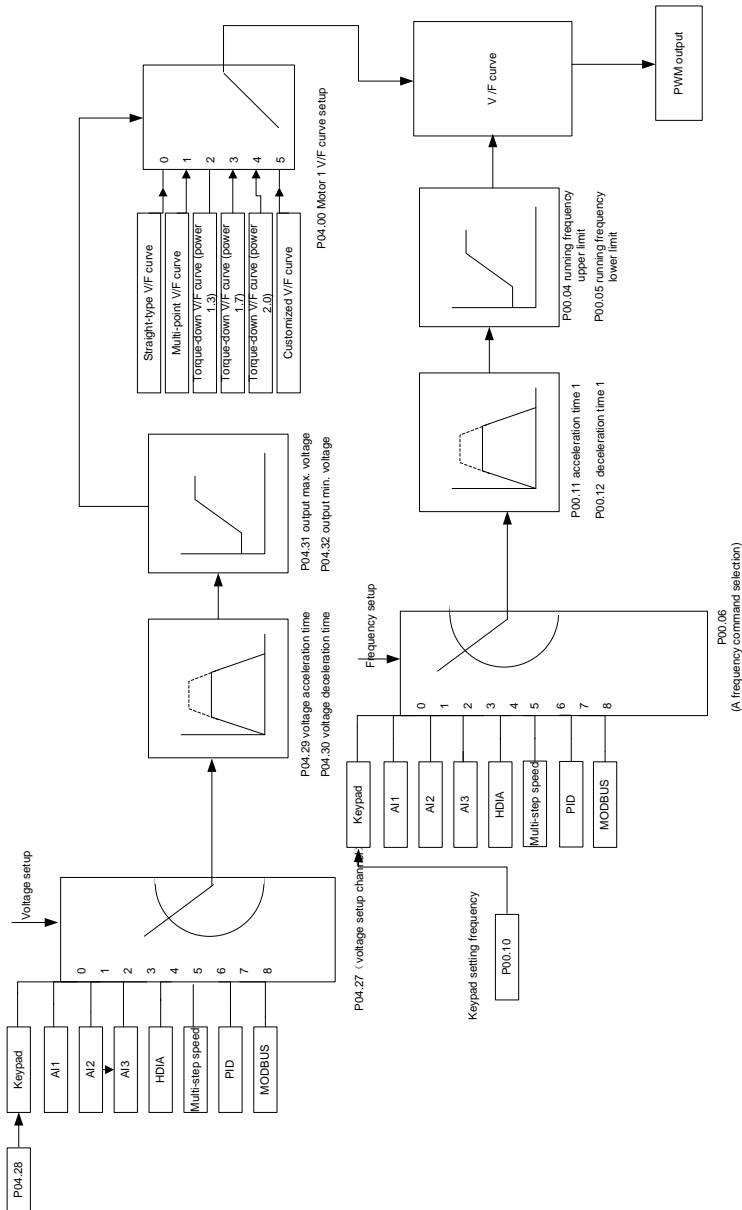

When selecting customized V/F curve function, users can set the reference channels and acceleration/deceleration time of voltage and frequency respectively, which will form a real-time V/F curve through combination.

**Note:** This kind of V/F curve separation can be applied in various frequency-conversion power sources, however, users should be cautious of parameter setup as improper setup may damage the machine.

Function code	Name	Detailed parameter description	Default value
P00.00	Speed control mode	1: SVC 1 2: V/F <b>Note:</b> If 1 is selected, it is required to carry out motor parameter autotuning first.	2
P00.03	Max. output frequency	P00.04–400.00Hz	50.00Hz
P00.04	Upper limit of running frequency	P00.05–P00.03	50.00Hz
P00.05	Lower limit of running frequency	0.00Hz–P00.04	0.00Hz
P00.11	Acceleration time 1	0.0–3600.0s	Depend on model
P00.12	Deceleration time 1	0.0–3600.0s	Depend on model
P02.02	Rated power of asynchronous motor 1	0.01Hz–P00.03 (Max. output frequency)	50.00Hz
P02.04	Rated voltage of asynchronous motor 1	0–1200V	Depend on model
P04.00	V/F curve setting of motor 1	0: Straight-type V/F curve 1: Multi-point V/F curve 2: Torque-down V/F curve (power 1.3) 3: Torque-down V/F curve (power 1.7) 4: Torque-down V/F curve (power 2.0) 5: Customized V/F (V/F separation)	0
P04.01	Torque boost of motor 1	0.0%: (automatic) 0.1%–10.0%	0.0%
P04.02	Motor 1 torque boost cut-off	0.0%–50.0% (rated frequency of motor 1)	20.0%
P04.03	V/F frequency point 1 of motor 1	0.00Hz–P04.05	0.00Hz
P04.04	V/F voltage point 1 of motor 1	0.0%–110.0%	0.0%
P04.05	V/F frequency point 2 of motor 1	P04.03– P04.07	0.00Hz
P04.06	V/F voltage point 2 of motor 1	0.0%–110.0%	0.0%

S1 series standard inverter

Function code	Name	Detailed parameter description	Default value
P04.07	V/F frequency point 3 of motor 1	P04.05– P02.02 or P04.05– P02.16	0.00Hz
P04.08	V/F voltage point 3 of motor 1	0.0%–110.0%	0.0%
P04.09	V/F slip compensation gain of motor 1	0.0–200.0%	100.0%
P04.10	Low-frequency oscillation control factor of motor 1	0–100	10
P04.11	High-frequency oscillation control factor of motor 1	0–100	10
P04.12	Oscillation control threshold of motor 1	0.00Hz–P00.03 (Max. output frequency)	30.00Hz
P04.13	V/F curve setup of motor 2	0: Straight V/F curve; 1: Multi-point V/F curve 2: Torque-down V/F curve (1.3 <sup>th</sup> order) 3: Torque-down V/F curve (1.7 <sup>th</sup> order) 4: Torque-down V/F curve (2.0 <sup>th</sup> order) 5: Customize V/F (V/F separation)	0
P04.14	Torque boost of motor 2	0.0%: (automatic) 0.1%–10.0%	0.0%
P04.15	Motor 2 torque boost cut-off	0.0%–50.0% (rated frequency of motor 1)	20.0%
P04.16	V/F frequency point 1 of motor 2	0.00Hz–P04.18	0.00Hz
P04.17	V/F voltage point 1 of motor 2	0.0%–110.0%	0.0%
P04.18	V/F frequency point 2 of motor 2	P04.16– P04.20	0.00Hz
P04.19	V/F voltage point 2 of motor 2	0.0%–110.0%	0.0%
P04.20	V/F frequency point 3 of motor 2	P04.18– P02.02 or P04.18– P02.16	0.00Hz
P04.21	V/F voltage point 3 of motor 2	0.0%–110.0%	0.0%
P04.22	V/F slip compensation gain of motor 2	0.0–200.0%	100.0%

S1 series standard inverter



Function code	Name	Detailed parameter description	Default value
P04.23	Low-frequency oscillation control factor of motor 2	0–100	10
P04.24	High-frequency oscillation control factor of motor 2	0–100	10
P04.25	Oscillation control threshold of motor 2	0.00Hz–P00.03 (Max. output frequency)	30.00Hz
P04.26	Energy-saving run	0: No 1: Automatic energy-saving run	0
P04.27	Channel of voltage setup	0: Keypad; output voltage is determined by P04.28 1: AI1 2: AI2 3: AI3 4: HDI/ HDIA 5: Multi-step 6: PID 7: Modbus communication 8 - 13: Reserved	0
P04.28	Set voltage value via keypad	0.0%–100.0% (rated motor voltage)	100.0%
P04.29	Voltage increase time	0.0–3600.0s	5.0s
P04.30	Voltage decrease time	0.0–3600.0s	5.0s
P04.31	Output max. voltage	P04.32–100.0% (rated motor voltage)	100.0%
P04.32	Output min. voltage	0.0%–P04.31 (rated motor voltage)	0.0%
P4.33	Flux-weakening coefficient in the constant power zone	1.00–1.30	1.00
P04.34	Enable/disable IF mode for asynchronous motor 1	0: Disabled 1: Enabled	0
P04.35	Current setting in IF mode for asynchronous motor 1	When IF control is adopted for asynchronous motor 1, this parameter is used to set the output current. The value is a percentage in relative to the rated current of the motor. Setting range: 0.0–200.0%	120.0%
P04.36	Proportional	When IF control is adopted for asynchronous motor	650



S1 series standard inverter

Function code	Name	Detailed parameter description	Default value
	coefficient in IF mode for asynchronous motor 1	1, this parameter is used to set the proportional coefficient of the output current closed-loop control. Setting range: 0–5000	
P04.37	Integral coefficient in IF mode for asynchronous motor 1	When IF control is adopted for asynchronous motor 1, this parameter is used to set the integral coefficient of the output current closed-loop control. Setting range: 0–5000	350

**5.5.5 Motor parameter**

	<ul style="list-style-type: none"> <li>◇ Check the safety conditions surrounding the motor and load machineries before autotuning as physical injury may occur due to sudden start of motor during autotuning.</li> <li>◇ Although the motor does not run during static autotuning, the motor is stilled supplied with power, do not touch the motor during autotuning; otherwise, electric shock may occur.</li> </ul>
	<ul style="list-style-type: none"> <li>◇ If the motor has been connected to load, do not carry out rotary autotuning; otherwise, misact or damage may occur to the inverter. If rotary autotuning is carried out on a motor which has been connected to load, wrong motor parameters and motor misacts may occur. Disconnect the load to carry out autotuning if necessary.</li> </ul>

S1 inverter can drive asynchronous motors, and it supports two sets of motor parameters, which can be switched over by multi-function digital input terminals or communication modes.

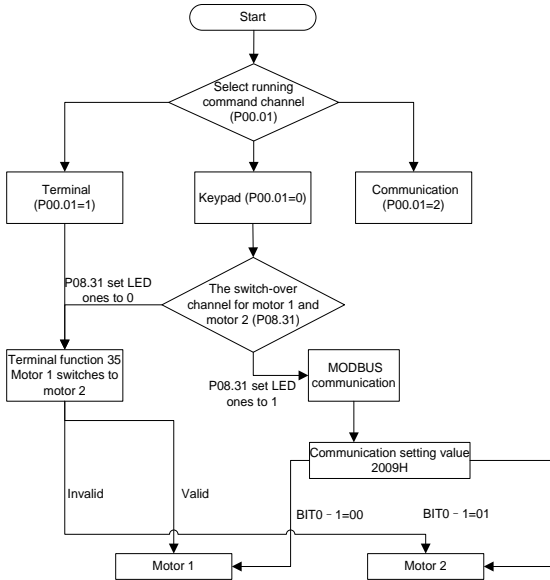

The control performance of the inverter is based on accurate motor model, therefore, users need to carry out motor parameter autotuning before running the motor for the first time (take motor 1 as an example)

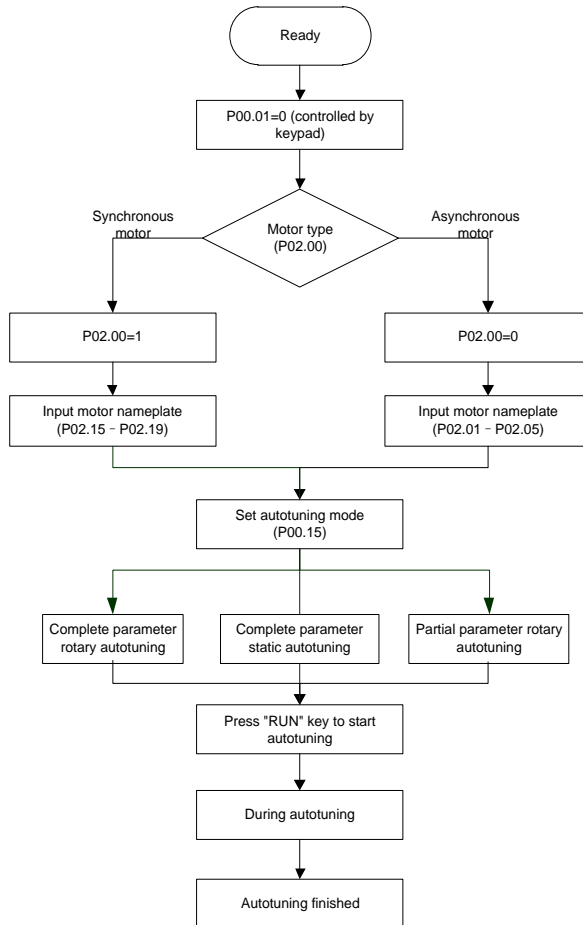

**Note:**

1. Motor parameters must be set correctly according to motor nameplate;
2. If rotary autotuning is selected during motor autotuning, it is a must to disconnect the motor from load to put the motor in static and no-load state, failed to do so may lead to inaccurate autotuned results. At this time, the asynchronous motor can autotune P02.06–P02.10
3. If static autotuning is selected during motor autotuning, there is no need to disconnect the motor from load, as only part of the motor parameters have been autotuned, the control performance may be impacted, under such situation, the asynchronous motor can autotune P02.06–P02.10
4. Motor autotuning can be carried out on current motor only, if users need to perform autotuning on the other motor, switch over the motor through selecting the switch-over channel of motor 1 and motor 2 by setting the ones of P08.31.

Related parameter list:

Function code	Name	Detailed parameter description	Default value
P00.01	Running command channel	0: Keypad 1: Terminal 2: Communication	1
P00.15	Motor parameter autotuning	0: No operation 1: Rotary autotuning; carry out comprehensive motor parameter autotuning; rotary autotuning is used in cases where high control precision is required; 2: Static autotuning 1 (comprehensive autotuning); static autotuning 1 is used in cases where the motor cannot be disconnected from load; 3: Static autotuning 2 (partial autotuning) ; when current motor is motor 1, only P02.06, P02.07 and P02.08 will be autotuned; when current motor is motor 2, only P12.06, P12.07 and P12.08 will be autotuned.	0
P02.01	Rated power of asynchronous motor 1	0.1–3000.0kW	Depend on model
P02.02	Rated frequency of asynchronous motor 1	0.01Hz–P00.03 (Max. output frequency)	50.00Hz
P02.03	Rated speed of asynchronous motor 1	1–36000rpm	Depend on model
P02.04	Rated voltage of asynchronous motor 1	0–1200V	Depend on model
P02.05	Rated current of asynchronous motor 1	0.8–6000.0A	Depend on model
P02.06	Stator resistance of asynchronous motor 1	0.001–65.535Ω	Depend on model
P02.07	Rotor resistance of asynchronous motor 1	0.001–65.535Ω	Depend on model
P02.08	Leakage inductance of asynchronous motor 1	0.1–6553.5mH	Depend on model
P02.09	Mutual inductance of asynchronous motor 1	0.1–6553.5mH	Depend on model

S1 series standard inverter

Function code	Name	Detailed parameter description	Default value
P02.10	No-load current of asynchronous motor 1	0.1–6553.5A	Depend on model
P05.01–P05.06	Function of multi-function digital input terminal (S1–S4, HDIA,HDIB)	35: Motor 1 switches to motor 2	/
P08.31	Switching between motor 1 and motor 2	0x00–0x14 Ones: Switch-over channel 0: Switch over by terminal 1: Switch over by Modbus communication 2 – 4 : Reserved Tens: Motor switch-over during running 0: Disable switch-over during running 1: Enable switch-over during running	00
P12.01	Rated power of asynchronous motor 2	0.1–3000.0kW	Depend on model
P12.02	Rated frequency of asynchronous motor 2	0.01Hz–P00.03 (Max. output frequency)	50.00Hz
P12.03	Rated speed of asynchronous motor 2	1–36000rpm	Depend on model
P12.04	Rated voltage of asynchronous motor 2	0–1200V	
P12.05	Rated current of asynchronous motor 2	0.8–6000.0A	
P12.06	Stator resistance of asynchronous motor 2	0.001–65.535Ω	
P12.07	Rotor resistance of asynchronous motor 2	0.001–65.535Ω	
P12.08	Leakage inductance of asynchronous motor 2	0.1–6553.5mH	
P12.09	Mutual inductance of asynchronous motor 2	0.1–6553.5mH	
P12.10	No-load current of asynchronous motor 2	0.1–6553.5A	

### **5.5.6 Start/stop control**

The start/stop control of the inverter is divided into three states: start after running command at power-up; start after restart-at-power-cut function is effective; start after automatic fault reset. Descriptions for these three start/stop control states are presented below.

There are three start modes for the inverter, which are start at starting frequency, start after DC brake, and start after speed-tracking. Users can select the proper start mode based on field conditions.

For large-inertia load, especially in cases where reversal may occur, users can choose to start after DC brake or start after speed-racking.

1. Logic diagram for running command after power-up

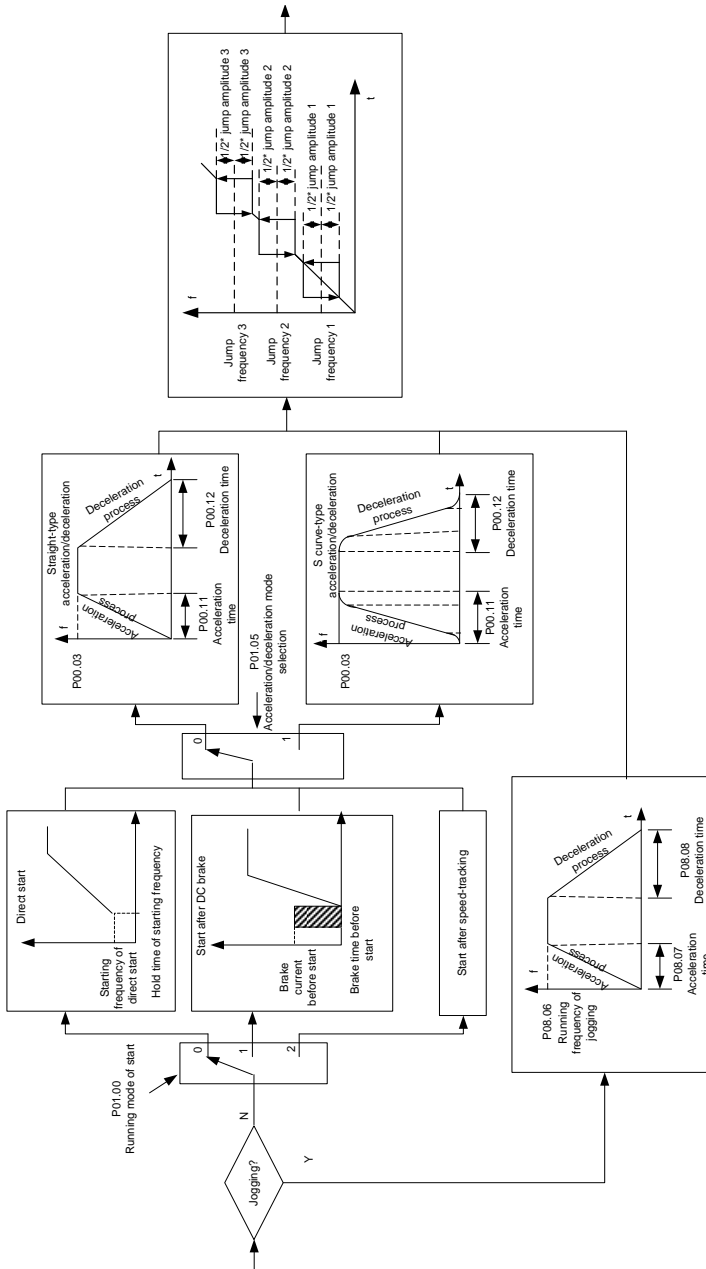

2. Logic diagram for restart after power down.

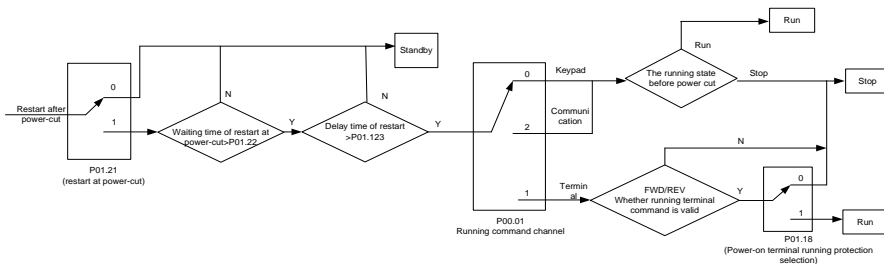

3. Logic diagram for restart after automatic fault reset

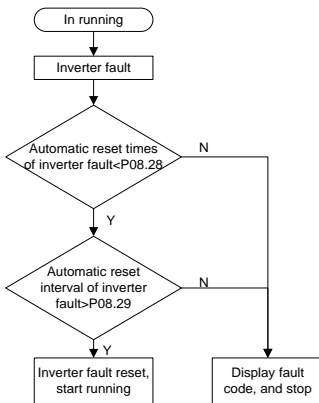

Related parameter list:

Function code	Name	Detailed parameter description	Default value
P00.01	Running command channel	0: Keypad 1: Terminal 2: Communication	1
P00.11	Acceleration time 1	0.0–3600.0s	Depend on model
P00.12	Deceleration time 1	0.0–3600.0s	Depend on model
P01.00	Running mode of start	0: Direct start 1: Start after DC brake 2: Start after speed-track 1 3: Start after speed-track 2	0
P01.01	Starting frequency of direct start	0.00–50.00Hz	0.50Hz
P01.02	Hold time of starting	0.0–50.0s	0.0s



S1 series standard inverter

Function code	Name	Detailed parameter description	Default value
	frequency		
P01.03	DC brake current before start	0.0–100.0%	0.0%
P01.04	DC brake time before start	0.00–50.00s	0.00s
P01.05	Acceleration/deceleration mode	0: Straight line 1: S curve Note: If mode 1 is selected, it is required to set P01.07, P01.27 and P01.08 accordingly	0
P01.08	Stop mode	0: Decelerate to stop 1: Coast to stop	0
P01.09	Starting frequency of DC brake after stop	0.00Hz–P00.03 (Max. output frequency)	0.00Hz
P01.10	Waiting time of DC brake after stop	0.00–50.00s	0.00s
P01.11	DC brake current of stop	0.0–100.0%	0.0%
P01.12	DC brake time of stop	0.00–50.00s	0.00s
P01.13	Deadzone time of forward/reverse rotation	0.0–3600.0s	0.0s
P01.14	Forward/reverse rotation switch-over mode	0: switch over after zero frequency 1: switch over after starting frequency 2: switch over after passing stop speed and delay	0
P01.15	Stop speed	0.00–100.00Hz	0.50 Hz
P01.16	Stop speed detection mode	0: Set value of speed (the only detection mode valid in V/F mode) 1: Detection value of speed	1
P01.18	Power-on terminal running protection selection	0: Terminal running command is invalid at power up 1: Terminal running command is valid at power up	0
P01.19	Action selection when the running frequency is below lower limit (lower limit should be larger than 0)	0: Run at the lower limit frequency 1: Stop 2: Sleep	0
P01.20	Wake-up-from-sleep delay	0.0–3600.0s (valid when P01.19 is 2)	0.0s
P01.21	Restart after power down	0: Restart is disabled 1: Restart is enabled	0

S1 series standard inverter

Function code	Name	Detailed parameter description	Default value
P01.22	Waiting time of restart after power down	0.0–3600.0s (valid when P01.21 is 1)	1.0s
P01.23	Start delay	0.0–60.0s	0.0s
P01.24	Stop speed delay	0.0–100.0s	0.0s
P01.25	Open-loop 0Hz output selection	0: No voltage output 1: With voltage output 2: Output as per DC brake current of stop	0
P01.26	Deceleration time of emergency-stop	0.0–60.0s	2.0s
P01.27	Time of starting section of deceleration S curve	0.0–50.0s	0.1s
P01.28	Time of ending section of deceleration S curve	0.0–50.0s	0.1s
P01.29	Short-circuit brake current	0.0–150.0% (rated inverter current)	0.0%
P01.30	Hold time of short-circuit brake at startup	0.00–50.00s	0.00s
P01.31	Hold time of short-circuit brake at stop	0.00–50.00s	0.00s
P05.01–P05.06	Digital input function selection	1: Forward running 2: Reverse running 4: Forward jogging 5: Reverse jogging 6: Coast to stop 7: Fault reset 8: Running pause 21: Acceleration/deceleration time selection 1 22: Acceleration/deceleration time selection 2 30: Acceleration/deceleration disabled	/
P08.06	Running frequency of jogging	0.00Hz–P00.03 (Max. output frequency)	5.00Hz
P08.07	Acceleration time at jogging	0.0–3600.0s	Depend on model
P08.08	Deceleration time at jogging	0.0–3600.0s	Depend on model
P08.00	Acceleration time 2	0.0–3600.0s	Depend on model

S1 series standard inverter

Function code	Name	Detailed parameter description	Default value
P08.01	Declaration time 2	0.0–3600.0s	Depend on model
P08.02	Acceleration time 3	0.0–3600.0s	Depend on model
P08.03	Declaration time 3	0.0–3600.0s	Depend on model
P08.04	Acceleration time 4	0.0–3600.0s	Depend on model
P08.05	Declaration time 4	0.0–3600.0s	Depend on model
P08.19	Switching frequency of acceleration/deceleration time	0.00–P00.03 (Max. output frequency) 0.00Hz: No switch over If the running frequency is larger than P08.19, switch to acceleration /deceleration time 2	0
P08.21	Reference frequency of acceleration/deceleration time	0: Max. output frequency 1: Set frequency 2: 100Hz Note: Valid for straight-line acceleration/deceleration only	0
P08.28	Automatic fault reset times	0–10	0
P08.29	Automatic fault reset time interval	0.1–3600.0s	1.0s

### 5.5.7 Frequency setup

S1 series inverter supports multiple kinds of frequency reference modes, which can be categorized into two types: main reference channel and auxiliary reference channel.

There are two main reference channels, namely frequency reference channel A and frequency reference channel B. These two channels support simple arithmetical operation between each other, and they can be switched dynamically by setting multi-function terminals.

There is one input mode for auxiliary reference channel, namely terminal UP/DOWN switch input. By setting function codes, users can enable the corresponding reference mode and the impact made on the inverter frequency reference by this reference mode.

The actual reference of inverter is comprised of the main reference channel and auxiliary reference channel.

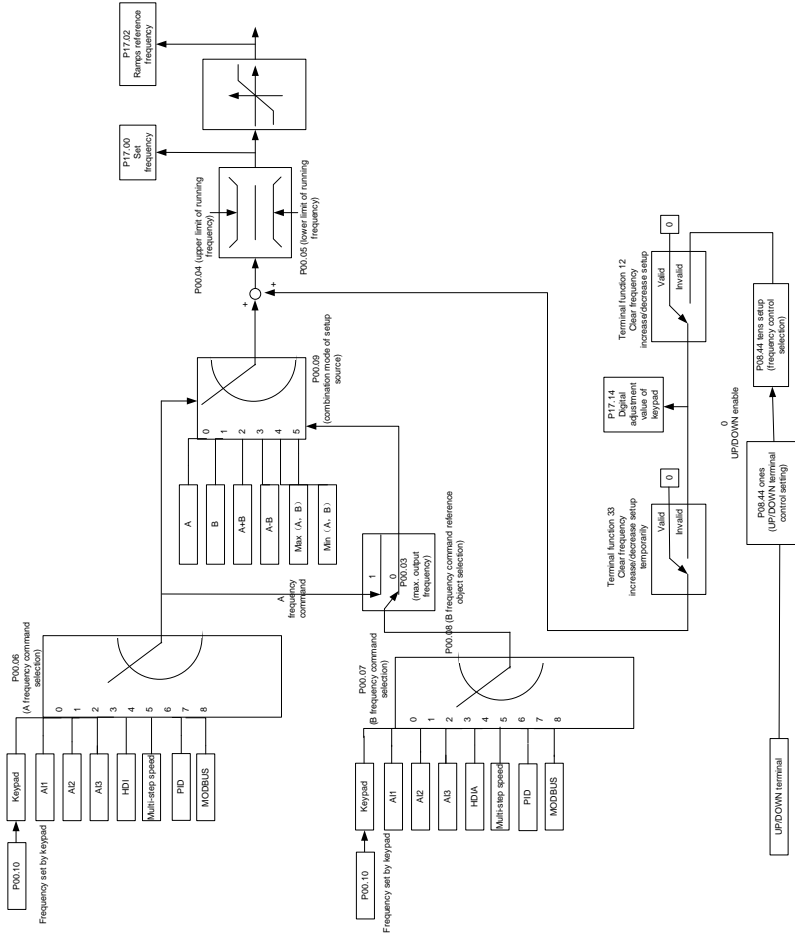

S1 inverter supports switch-over between different reference channels, and the rules for channel switch-over are shown below.

Present reference channel P00.09	Multi-function terminal function 13 Channel A switches to channel B	Multi-function terminal function 14 Combination setup switches to channel A	Multi-function terminal function 15 Combination setup switches to channel B
A	B	/	/
B	A	/	/
A+B	/	A	B
A-B	/	A	B

Present reference channel P00.09	Multi-function terminal function 13 Channel A switches to channel B	Multi-function terminal function 14 Combination setup switches to channel A	Multi-function terminal function 15 Combination setup switches to channel B
Max (A, B)	/	A	B
Min (A, B)	/	A	B

**Note:** "/" indicates this multi-function terminal is invalid under present reference channel.

When setting the auxiliary frequency inside the inverter via multi-function terminal UP (10) and DOWN (11), users can increase/decrease the frequency quickly by setting P08.45 (UP terminal frequency incremental change rate) and P08.46 (DOWN terminal frequency decremental change rate).

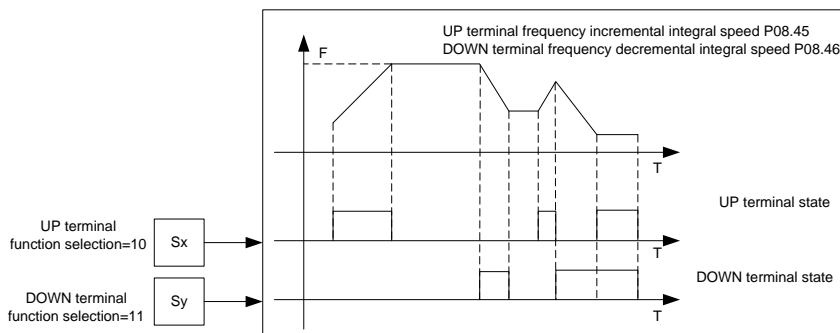

Related parameter list:

Function code	Name	Detailed parameter description	Default value
P00.03	Max. output frequency	P00.04–400.00Hz	50.00Hz
P00.04	Upper limit of running frequency	P00.05–P00.03	50.00Hz
P00.05	Lower limit of running frequency	0.00Hz–P00.04	0.00Hz
P00.06	A frequency command selection	0: Set via keypad 1: Set via AI1 2: Set via AI2 3: Set via AI3	2
P00.07	B frequency command selection	4: Set via high speed pulse HDI/HDIA 5: Reserved 6: Set via multi-step speed running 7: Set via PID control 8: Set via Modbus communication	5

S1 series standard inverter

Function code	Name	Detailed parameter description	Default value
		9–15: Reserved Note: for models 4kW and above 1: No function 2: AI1 3: AI2	
P00.08	Reference object of B frequency command	0: Max. output frequency 1: A frequency command	0
P00.09	Combination mode of setup source	0: A 1: B 2: (A+B) 3: (A-B) 4: Max (A, B) 5: Min (A, B)	0
P05.01– P05.06	Function of multi-function digital input terminal (S1–S4, HDIA, HDIB)	10: Frequency increase (UP) 11: Frequency decrease (DOWN) 12: Clear frequency increase/decrease setting 13: Switch-over between setup A and setup B 14: Switch-over between combination setup and setup A 15: Switch-over between combination setup and setup B	/
P08.42	Keypad digital control setting	0x0000 – 0x1223 LED ones: frequency enable selection 0: Both $\wedge/\vee$ keys and analog potentiometer adjustments are valid 1: Only $\wedge/\vee$ keys adjustment is valid 2: Only analog potentiometer adjustments is valid 3: Neither $\wedge/\vee$ keys nor digital potentiometer adjustments are valid LED tens: frequency control selection 0: Valid only when P00.06=0 or P00.07=0 1: Valid for all frequency setting modes 2: Invalid for multi-step speed when multi-step speed has the priority LED hundreds: action selection during stopping 0: Setting is valid 1: Valid during running, cleared after stopping 2: Valid during running, cleared after	0x000

Function code	Name	Detailed parameter description	Default value
		receiving the stop command LED thousands: $\wedge/\vee$ keys and analog potentiometer integral function 0: The Integral function is valid 1: The Integral function is invalid	
P08.43	Reserved variables	/	/
P08.44	UP/DOWN terminal control	0x000–0x221 Ones: Frequency enabling selection 0: Setting through the UP/DOWN terminal is valid 1: Setting through the UP/DOWN terminal is invalid Tens: Frequency control selection 0: Valid only when P00.06=0 or P00.07=0 1: Valid for all frequency modes 2: Invalid for multi-step speed when multi-step speed takes priority Hundreds: Action selection at stop 0: Valid 1: Valid during running, clear after stop 2: Valid during running, clear after receiving stop command	0x000
P08.45	UP terminal frequency incremental change rate	0.01–50.00 Hz/s	0.50 Hz/s
P08.46	DOWN terminal frequency decremental change rate	0.01–50.00 Hz/s	0.50 Hz/s
P17.00	Set frequency	0.00Hz–P00.03 (Max. output frequency)	0.00Hz
P17.02	Ramps reference frequency	0.00Hz–P00.03 (Max. output frequency)	0.00Hz
P17.14	Digital adjustment value	0.00Hz–P00.03	0.00Hz

### 5.5.8 Analog input

S1 series inverter carries two analog input terminals (For model  $\geq 4\text{kW}$ , they are AI1 and AI2. AI1 is 0–10V/0–20mA (voltage input or current input can be set by P05.50); AI2 is -10–10V; For models up to 2.2kW, they are AI2 and AI3. AI2 is 0–10V/0–20mA (voltage input or current input can be set by jumpers); AI3 is -10–10V) and two high-speed pulse input terminals. Each input can be filtered separately, and the corresponding reference curve can be set by adjusting the reference corresponds to the max. value and min. value.

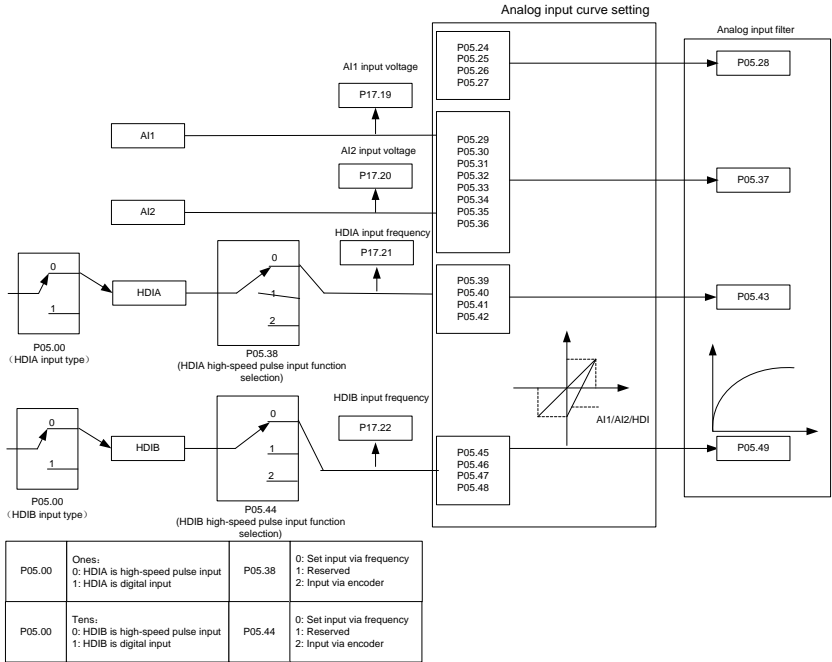

Related parameter list:

Function code	Name	Detailed parameter description	Default value
P05.00	HDI input type	0x00–0x11 Ones: HDI/HDIA input type 0: HDI/HDIA is high-speed pulse input 1: HDI/HDIA is digital input Tens: HDIB input type 0: HDIB is high-speed pulse input 1: HDIB is digital input	0x00
P05.24	Lower limit value of AI1	0.00V–P05.26	0.00V
P05.25	Corresponding setting of lower limit of AI1	-100.0%–100.0%	0.0%
P05.26	Upper limit value of AI1	P05.24–10.00V	10.00V
P05.27	Corresponding setting of upper limit of AI1	-100.0%–100.0%	100.0%
P05.28	Input filter time of AI1	0.000s–10.000s	0.100s
P05.29	Lower limit value of AI2	-10.00V–P05.31	-10.00V



S1 series standard inverter

Function code	Name	Detailed parameter description	Default value
P05.30	Corresponding setting of lower limit of AI2	-100.0%–100.0%	-100.0%
P05.31	Intermediate value 1 of AI2	P05.29–P05.33	0.00V
P05.32	Corresponding setting of intermediate value 1 of AI2	-100.0%–100.0%	0.0%
P05.33	Intermediate value 2 of AI2	P05.31–P05.35	0.00V
P05.34	Corresponding setting of intermediate value 2 of AI2	-100.0%–100.0%	0.0%
P05.35	Upper limit value of AI2	P05.33–10.00V	10.00V
P05.36	Corresponding setting of upper limit of AI2	-100.0%–100.0%	100.0%
P05.37	Input filter time of AI2	0.000s–10.000s	0.100s
P05.38	Lower limit of AI3	-10.00V–P05.39	-10.00V
P05.39	Corresponding setting of the lower limit of AI3	-100.0%–100.0%	-100.0%
P05.40	Middle value of AI3	P05.38–P05.42	0.00V
P05.41	Corresponding middle setting of AI3	-100.0%–100.0%	0.0%
P05.42	Upper limit of AI3	P05.40–10.00V	10.00V
P05.43	Corresponding setting of the upper limit of AI3	-100.0%–100.0%	100.0%
P05.44	AI3 input filter time	0.000s–10.000s	0.100s
P05.45	Lower limit frequency of HDI/HDIA	0.000 KHz – P05.41	0.000KHz
P05.46	Corresponding setting of lower limit frequency of HDI/HDIA	-100.0%–100.0%	0.0%
P05.47	Upper limit frequency of HDI/HDIA	P05.39 –50.000KHz	50.000KHz
P05.48	Corresponding setting of upper limit frequency of HDI/HDIA	-100.0%–100.0%	100.0%
P05.49	HDI/HDIA frequency input filter time	0.000s–10.000s	0.030s
P05.50	Lower limit frequency of HDIB	0.000 KHz – P05.47	0.000KHz
P05.51	Corresponding setting of lower limit frequency of HDIB	-100.0%–100.0%	0.0%

Function code	Name	Detailed parameter description	Default value
P05.52	Upper limit frequency of HDIB	P05.45 –50.000KHz	50.000KHz
P05.53	Corresponding setting of upper limit frequency of HDIB	-100.0%–100.0%	100.0%
P05.54	HDIB frequency input filter time	0.000s–10.000s	0.030s
P05.55	AI1 input signal type	0–1 0: Voltage type 1: Current type	0

### 5.5.9 Analog output

S1 series inverter carries one analog output terminal (0–10V/0–20mA) and one high-speed pulse output terminal. Analog output signals can be filtered separately, and the proportional relation can be adjusted by setting the max. value, min. value, and the percentage of their corresponding output. Analog output signal can output motor speed, output frequency, output current, motor torque and motor power at a certain proportion.

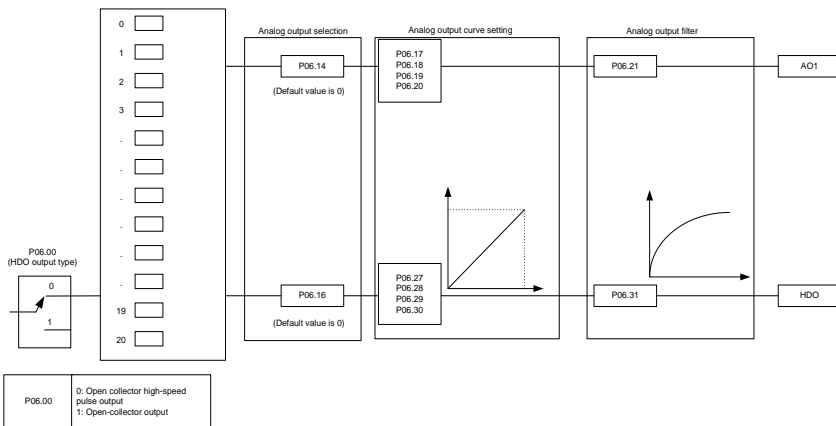

Instructions for output:

Set value	Function	Description
0	Running frequency	0–Max. output frequency
1	Set frequency	0–Max. output frequency
2	Ramps reference frequency	0–Max. output frequency
3	Running speed	0–Synchronous speed corresponding to Max. output frequency
4	Output current (relative to	0–Two times of rated current of inverter

S1 series standard inverter

Set value	Function	Description
	inverter)	
5	Output current (relative to motor)	0–Two times of rated current of motor
6	Output voltage	0–1.5 times of rated voltage of inverter
7	Output power	0–Two times of rated power
8	Set torque value	0–Two times of rated current of motor
9	Output torque	0–Two times of rated current of motor
10	AI1 input value	0–10V/0–20mA
11	AI2 input value	-10V–10V
12	AI3 input value	0–10V/0–20mA
13	Input value of high-speed pulse HDI/HDIA	0.00–50.00kHz
14	Set value 1 of Modbus communication	-1000–1000, 1000 corresponds to 100.0%
15	Set value 2 of Modbus communication	-1000–1000, 1000 corresponds to 100.0%
22	Torque current (bipolar, 100% corresponds to 10V)	0–Two times of rated current of motor
23	Ramps reference frequency (bipolar)	0–Max. output frequency

Related parameter list:

Function code	Name	Detailed parameter description	Default value
P06.00	HDO output type	0: Open collector high-speed pulse output 1: Open collector output	0
P06.14	AO1 output selection	0: Running frequency	0
P06.15	Reserved variable	1: Set frequency	0
P06.16	HDO high-speed pulse output	2: Ramps reference frequency 3: Running speed 4: Output current (relative to inverter) 5: Output current (relative to motor) 6: Output voltage 7: Output power 8: Set torque value 9: Output torque 10: Analog AI1 input value	0

S1 series standard inverter

Function code	Name	Detailed parameter description	Default value
		11: Analog AI2 input value 12: Analog AI3 input value 13: Input value of high-speed pulse HDI/HDIA 14: Set value 1 of Modbus communication 15: Set value 2 of Modbus communication 16 - 21: Seserved 22: Torque current (bipolar, 100% corresponds to 10V) 23: Ramps reference frequency (bipolar)	
P06.17	Lower limit of AO1 output	-100.0%~P06.19	0.0%
P06.18	Corresponding AO1 output of lower limit	0.00V~10.00V	0.00V
P06.19	Upper limit of AO1 output	P06.17~100.0%	100.0%
P06.20	Corresponding AO1 output of upper limit	0.00V~10.00V	10.00V
P06.21	AO1 output filter time	0.000s~10.000s	0.000s
P06.22~P06.26	Reserved variable	0~65535	0
P06.27	Lower limit of HDO output	-100.0%~P06.29	0.0%
P06.28	Corresponding HDO output of lower limit	0.00~50.00kHz	0.0kHz
P06.29	Upper limit of HDO output	P06.27~100.0%	100.0%
P06.30	Corresponding HDO output of upper limit	0.00~50.00kHz	50.00kHz
P06.31	HDO output filter time	0.000s~10.000s	0.000s

**5.5.10 Digital input**

S1 series inverter carries four programmable digital input terminals and two HDI input terminals. The function of all the digital input terminals can be programmed by function codes. HDI input terminal can be set to act as high-speed pulse input terminal or common digital input terminal; if it is set to act as high-speed pulse input terminal, users can also set HDIA or HDIB high-speed pulse input to serve as the frequency reference and encoder signal input.

## S1 series standard inverter

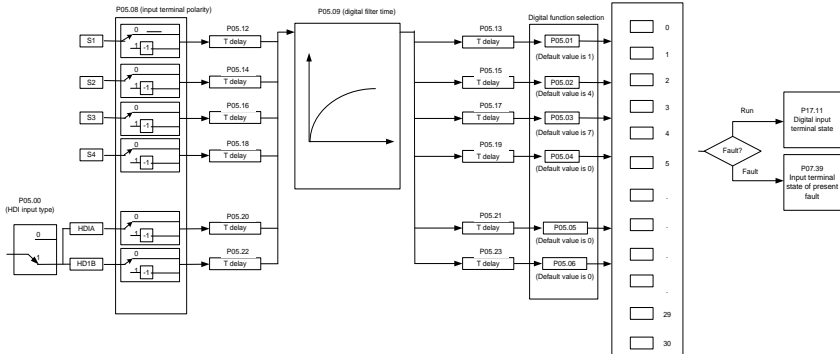

This parameter is used to set the corresponding function of digital multi-function input terminals.

**Note:** Two different multi-function input terminals cannot be set to the same function.

Set value	Function	Description
0	No function	The inverter does not act even if there is signal input; users can set the unused terminals to "no function" to avoid misacts.
1	Forward running (FWD)	Control the forward/reverse running of the inverter by external terminals.
2	Reverse running (REV)	
3	3-wire control/Sin	Set the inverter running mode to 3-wire control mode by this terminal. See P05.13 for details.
4	Forward jogging	Frequency when jogging, see P08.06, P08.07 and P08.08 for jogging acceleration/deceleration time.
5	Reverse jogging	
6	Coast to stop	The inverter blocks output, and the stop process of motor is uncontrolled by the inverter. This mode is applied in cases of large-inertia load and free stop time; its definition is the same with P01.08, and it is mainly used in remote control.
7	Fault reset	External fault reset function, its function is the same with the <b>STOP/RST</b> key on the keypad. This function can be used in remote fault reset.
8	Running pause	The inverter decelerates to stop, however, all the running parameters are in memory state, eg PLC parameter, wobbling frequency, and PID parameter. After this signal disappears, the inverter will revert to the state before stop.
9	External fault input	When external fault signal is transmitted to the inverter, the inverter releases fault alarm and stops.

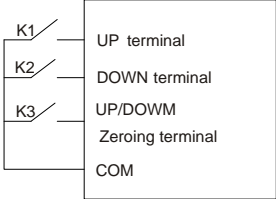
Set value	Function	Description								
10	Frequency increase (UP)	Used to change the frequency-increase/decrease command when the frequency is given by external terminals.								
11	Frequency decrease (DOWN)									
12	Clear frequency increase/decrease setting	 <p>The terminal used to clear frequency-increase/decrease setting can clear the frequency value of auxiliary channel set by <b>UP/DOWN</b>, thus restoring the reference frequency to the frequency given by main reference frequency command channel.</p>								
13	Switching between A setting and B setting	This function is used to switch between the frequency setting channels.								
14	Switching between combination setting and A setting	A frequency reference channel and B frequency reference channel can be switched by no. 13 function; the combination channel set by P00.09 and the A frequency reference channel can be switched by no. 14 function; the combination channel set by P00.09 and the B frequency reference channel can be switched by no. 15 function.								
15	Switching between combination setting and B setting									
16	Multi-step speed terminal 1	16-step speeds can be set by combining digital states of these four terminals. <b>Note: Multi-step speed 1 is low bit, multi-step speed 4 is high bit.</b>								
17	Multi-step speed terminal 2									
18	Multi-step speed terminal 3									
19	Multi-step speed terminal 4									
		<table border="1" data-bbox="492 1101 974 1204"> <tr> <td>Multi-step speed 4</td> <td>Multi-step speed 3</td> <td>Multi-step speed 2</td> <td>Multi-step speed 1</td> </tr> <tr> <td><b>BIT3</b></td> <td><b>BIT2</b></td> <td><b>BIT1</b></td> <td><b>BIT0</b></td> </tr> </table>	Multi-step speed 4	Multi-step speed 3	Multi-step speed 2	Multi-step speed 1	<b>BIT3</b>	<b>BIT2</b>	<b>BIT1</b>	<b>BIT0</b>
Multi-step speed 4	Multi-step speed 3	Multi-step speed 2	Multi-step speed 1							
<b>BIT3</b>	<b>BIT2</b>	<b>BIT1</b>	<b>BIT0</b>							
20	Multi-step speed pause	Pause multi-step speed selection function to keep the set value in present state.								
21	Acceleration/deceleration time selection 1	Use these two terminals to select four groups of acceleration/decoration time.								

Set value	Function	Description			
22	Acceleration/deceleration time selection 2	Terminal 1	Terminal 2	Acceleration or deceleration time selection	Corresponding parameter
		OFF	OFF	Acceleration/ deceleration time 1	P00.11/P00.12
		ON	OFF	Acceleration/ deceleration time 2	P08.00/P08.01
		OFF	ON	Acceleration/ deceleration time 3	P08.02/P08.03
		ON	ON	Acceleration/ deceleration time 4	P08.04/P08.05
25	PID control pause	PID is ineffective temporarily, and the inverter maintains current frequency output.			
26	Wobbling frequency pause (stop at current frequency)	The inverter pauses at current output. After this function is canceled, it continues wobbling-frequency operation at current frequency.			
27	Wobbling frequency reset (revert to center frequency)	The set frequency of inverter reverts to center frequency.			
28	Counter reset	Zero out the counter state.			
29	Switching between speed control and torque control	The inverter switches from torque control mode to speed control mode, or vice versa.			
30	Acceleration/deceleration disabled	Ensure the inverter will not be impacted by external signals (except for stop command), and maintains current output frequency.			
31	Counter trigger	Enable pulse counting of the counter.			
33	Clear frequency increase/decrease setting temporarily	When the terminal is closed, the frequency value set by <b>UP/DOWN</b> can be cleared to restore the reference frequency to the frequency given by frequency command channel; when terminal is disconnected, it will revert to the frequency value after frequency increase/decrease setting.			
34	DC brake	The inverter starts DC brake immediately after the command becomes valid.			
35	Switching between motor 1 and motor 2	When this terminal is valid, users can realize switch-over control of two motors.			
36	Command switches to keypad	When this terminal is valid, the running command channel will switch to keypad compulsorily. If this function becomes invalid, the running command channel will			

S1 series standard inverter

Set value	Function	Description
		revert to the original state.
37	Command switches to terminal	When this terminal is valid, the running command channel will switch to terminal compulsorily. If this function becomes invalid, the running command channel will revert to the original state.
38	Command switches to communication	When this terminal is valid, the running command channel will switch to communication compulsorily. If this function becomes invalid, the running command channel will revert to the original state.
39	Pre-exciting command	When this terminal is valid, motor pre-exciting will be started until this terminal becomes invalid.
40	Zero out power consumption quantity	After this command becomes valid, the power consumption quantity of the inverter will be zeroed out.
41	Maintain power consumption quantity	When this command is valid, current operation of the inverter will not impact the power consumption quantity.
42	Emergency stop	When this command is valid, the motor decelerate to emergency stop as per the time set by P01.26.
61	PID polarity switch-over	Switching the output polarity of PID, this terminal should be used in conjunction with P09.03

Related parameter list:

Function code	Name	Detailed parameter description	Default value
P05.00	HDI input type	0x00–0x11 Ones: HDIA input type 0: HDIA is high-speed pulse input 1: HDIA is digital input Tens: HDIB input type 0: HDIB is high-speed pulse input 1: HDIB is digital input Note: up to 2.2kW only there is 1 channel HDI	0x00
P05.01	Function of S1 terminal	0: No function	1
P05.02	Function of S2 terminal	1: Forward running	4
P05.03	Function of S3 terminal	2: Reverse running	7
P05.04	Function of S4 terminal	3: 3-wire control/Sin	0
P05.05	Function of HDI/HDIA terminal	4: Forward jogging	0
P05.06	Function of HDIB terminal	5: Reverse jogging	0
		6: Coast to stop	0



Function code	Name	Detailed parameter description	Default value
P05.07	Reserved variables	7: Fault reset 8: Running pause 9: External fault input 10: Frequency increase (UP) 11: Frequency decrease (DOWN) 12: Clear frequency increase/decrease setting 13: Switch-over between setup A and setup B 14: Switch-over between combination setting and A setting 15: Switch-over between combination setting and setup B 16: Multi-step speed terminal 1 17: Multi-step speed terminal 2 18: Multi-step speed terminal 3 19: Multi-step speed terminal 4 20: Multi-step speed pause 21: Acceleration/deceleration time selection 1 22: Acceleration/deceleration time selection 2 25: PID control pause 26: Wobbling frequency pause 27: Wobbling frequency reset 28: Counter reset 29: Switching between speed control and torque control 30: Acceleration/deceleration disabled 31: Counter trigger 32: Reserved 33: Clear frequency increase/decrease setting temporarily 34: DC brake 35: Switching between motor 1 and motor 2 36: Command switches to keypad	0

S1 series standard inverter

Function code	Name	Detailed parameter description	Default value
		37: Command switches to terminal 38: Command switches to communication 39: Pre-exciting command 40: Zero out power consumption quantity 41: Maintain power consumption quantity 42: Emergency stop 61: PID polarity switch-over	
P05.08	Polarity of input terminal	0x00–0x3F	0x00
P05.09	Digital filter time	0.000–1.000s	0.010s
P05.10	Virtual terminal setting	0x00–0x3F (0: disable, 1: enable) BIT0: S1 virtual terminal BIT1: S2 virtual terminal BIT2: S3 virtual terminal BIT3: S4 virtual terminal BIT4: HDI/HDIA virtual terminal BIT5: HDIB virtual terminal	0x00
P05.11	2/3-wire control mode	0: 2-wire control 1 1: 2-wire control 2 2: 3-wire control 1 3: 3-wire control 2	0
P05.12	S1 terminal switch-on delay	0.000–50.000s	0.000s
P05.13	S1 terminal switch-off delay	0.000–50.000s	0.000s
P05.14	S2 terminal switch-on delay	0.000–50.000s	0.000s
P05.15	S2 terminal switch-off delay	0.000–50.000s	0.000s
P05.16	S3 terminal switch-on delay	0.000–50.000s	0.000s
P05.17	S3 terminal switch-off delay	0.000–50.000s	0.000s
P05.18	S4 terminal switch-on delay	0.000–50.000s	0.000s
P05.19	S4 terminal switch-off delay	0.000–50.000s	0.000s
P05.20	HDI/HDIA terminal switch-on delay	0.000–50.000s	0.000s
P05.21	HDI/HDIA terminal switch-off delay	0.000–50.000s	0.000s
P05.22	HDIB terminal switch-on delay	0.000–50.000s	0.000s

Function code	Name	Detailed parameter description	Default value
P05.23	HDIB terminal switch-off delay	0.000–50.000s	0.000s
P07.39	Input terminal state of present fault	/	0
P17.12	Digital input terminal state	/	0

**5.5.11 Digital output**

S1 series inverter carries two groups of relay output terminals, one open collector Y output terminal and one high-speed pulse output (HDO) terminal. The function of all the digital output terminals can be programmed by function codes, of which the high-speed pulse output terminal HDO can also be set to high-speed pulse output or digital output by function code.

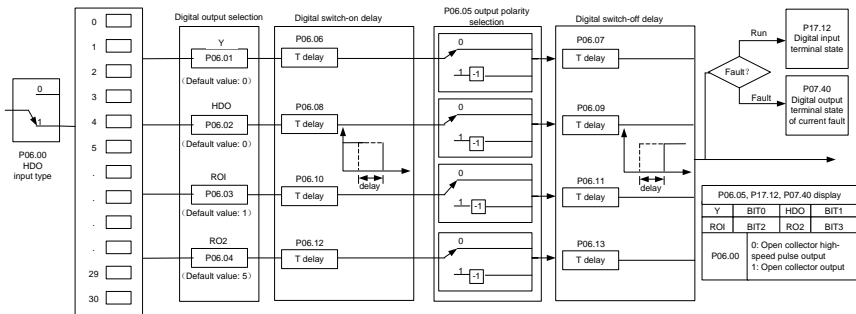

The table below lists the options for the above four function parameters, and users are allowed to select the same output terminal functions repetitively.

Set value	Function	Description
0	Invalid	Output terminal has no function
1	In running	Output ON signal when there is frequency output during running
2	In forward running	Output ON signal when there is frequency output during forward running
3	In reverse running	Output ON signal when there is frequency output during reverse running
4	In jogging	Output ON signal when there is frequency output during jogging
5	Inverter fault	Output ON signal when inverter fault occurred
6	Frequency level detection FDT1	Refer to P08.32 and P08.33
7	Frequency level detection FDT2	Refer to P08.34 and P08.35

S1 series standard inverter

Set value	Function	Description
8	Frequency reached	Refer to P08.36
9	Running in zero speed	Output ON signal when the inverter output frequency and reference frequency are both zero.
10	Reach upper limit frequency	Output ON signal when the running frequency reaches upper limit frequency
11	Reach lower limit frequency	Output ON signal when the running frequency reached lower limit frequency
12	Ready to run	Main circuit and control circuit powers are established, the protection functions do not act; when the inverter is ready to run, output ON signal.
13	In pre-exciting	Output ON signal during pre-exciting of the inverter
14	Overload pre-alarm	Output ON signal after the pre-alarm time elapsed based on the pre-alarm threshold; see P11.08–P11.10 for details.
15	Underload pre-alarm	Output ON signal after the pre-alarm time elapsed based on the pre-alarm threshold; see P11.11–P11.12 for details.
23	Virtual terminal output of Modbus communication	Output corresponding signal based on the set value of Modbus; output ON signal when it is set to 1, output OFF signal when it is set to 0
24	Reserved variables	/
25	Reserved variables	/
26	DC bus voltage established	Output is valid when the bus voltage is above the undervoltage threshold of the inverter
27	STO action	Output when STO fault occurred

Related parameter list:

Function code	Name	Detailed parameter description	Default value
P06.00	HDO output type	0: Open collector high-speed pulse output 1: Open collector output	0
P06.01	Y output selection	0: Invalid	0
P06.02	HDO output selection	1: In running	0
P06.03	Relay RO1 output selection	2: In forward running 3: In reverse running	1
P06.04	Relay RO2 output selection	4: In jogging 5: Inverter fault 6: Frequency level detection FDT1 7: Frequency level detection FDT2	5

S1 series standard inverter

Function code	Name	Detailed parameter description	Default value
		8: Frequency reached 9: Running in zero speed 10: Reach upper limit frequency 11: Reach lower limit frequency 12: Ready to run 13: In pre-exciting 14: Overload pre-alarm 15: Underload pre-alarm 16 – 17: Reserved 18: Reach set counting value 19: Reach designated counting value 20: External fault is valid 21: Reserved 22: Reach running time 23: Virtual terminal output of Modbus communication 24 -25: Reserved 26: DC bus voltage established 27: STO action 48–63: Reserved	
P06.05	Output terminal polarity selection	0x00–0x0F	0x00
P06.06	Y switch-on delay	0.000–50.000s	0.000s
P06.07	Y switch-off delay	0.000–50.000s	0.000s
P06.08	HDO switch-on delay	0.000–50.000s (valid only when P06.00=1)	0.000s
P06.09	HDO switch-off delay	0.000–50.000s (valid only when P06.00=1)	0.000s
P06.10	Relay RO1 switch-on delay	0.000–50.000s	0.000s
P06.11	Relay RO1 switch-off delay	0.000–50.000s	0.000s
P06.12	Relay RO2 switch-on delay	0.000–50.000s	0.000s
P06.13	Relay RO2 switch-off delay	0.000–50.000s	0.000s
P07.40	Output terminal state of present fault	/	0
P17.13	Digital output terminal state	/	0

### 5.5.12 Multi-step speed running

Set the parameters used in multi-step speed running. S1 inverter can set 16-step speeds, which are selectable by multi-step speed terminals 1–4, corresponding to multi-step speed 0 to multi-step speed 15.

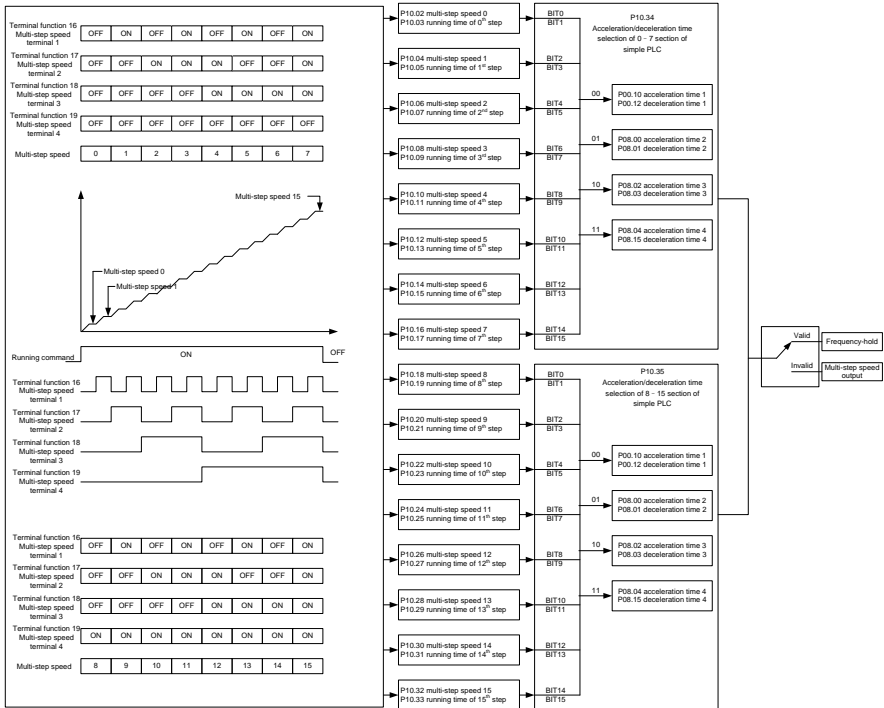

Related parameter list:

Function code	Name	Detailed parameter description	Default value
P10.02	Multi-step speed 0	-100.0–100.0%	0.0%
P10.03	Running time of 0 <sup>th</sup> step	0.0–6553.5s (min)	0.0s
P10.04	Multi-step speed 1	-100.0–100.0%	0.0%
P10.05	Running time of 1 <sup>st</sup> step	0.0–6553.5s (min)	0.0s
P10.06	Multi-step speed 2	-100.0–100.0%	0.0%
P10.07	Running time of 2 <sup>nd</sup> step	0.0–6553.5s (min)	0.0s
P10.08	Multi-step speed 3	-100.0–100.0%	0.0%
P10.09	Running time of 3 <sup>rd</sup> step	0.0–6553.5s (min)	0.0s
P10.10	Multi-step speed 4	-100.0–100.0%	0.0%
P10.11	Running time of 4 <sup>th</sup> step	0.0–6553.5s (min)	0.0s

Function code	Name	Detailed parameter description	Default value
P10.12	Multi-step speed 5	-100.0–100.0%	0.0%
P10.13	Running time of 5 <sup>th</sup> step	0.0–6553.5s (min)	0.0s
P10.14	Multi-step speed 6	-100.0–100.0%	0.0%
P10.15	Running time of 6 <sup>th</sup> step	0.0–6553.5s (min)	0.0s
P10.16	Multi-step speed 7	-100.0–100.0%	0.0%
P10.17	Running time of 7 <sup>th</sup> step	0.0–6553.5s (min)	0.0s
P10.18	Multi-step speed 8	-100.0–100.0%	0.0%
P10.19	Running time of 8 <sup>th</sup> step	0.0–6553.5s (min)	0.0s
P10.20	Multi-step speed 9	-100.0–100.0%	0.0%
P10.21	Running time of 9 <sup>th</sup> step	0.0–6553.5s (min)	0.0s
P10.22	Multi-step speed 10	-100.0–100.0%	0.0%
P10.23	Running time of 10 <sup>th</sup> step	0.0–6553.5s (min)	0.0s
P10.24	Multi-step speed 11	-100.0–100.0%	0.0%
P10.25	Running time of 11 <sup>th</sup> step	0.0–6553.5s (min)	0.0s
P10.26	Multi-step speed 12	-100.0–100.0%	0.0%
P10.27	Running time of 12 <sup>th</sup> step	0.0–6553.5s (min)	0.0s
P10.28	Multi-step speed 13	-100.0–100.0%	0.0%
P10.29	Running time of 13 <sup>th</sup> step	0.0–6553.5s (min)	0.0s
P10.30	Multi-step speed 14	-100.0–100.0%	0.0%
P10.31	Running time of 14 <sup>th</sup> step	0.0–6553.5s (min)	0.0s
P10.32	Multi-step speed 15	-100.0–100.0%	0.0%
P10.33	Running time of 15 <sup>th</sup> step	0.0–6553.5s (min)	0.0s
P05.01– P05.06	Digital input function selection	16: Multi-step speed terminal 1 17: Multi-step speed terminal 2 18: Multi-step speed terminal 3 19: Multi-step speed terminal 4 20: Multi-step speed pause	/

### 5.5.13 PID control

PID control, a common mode for process control, is mainly used to adjust the inverter output frequency or output voltage through performing scale-division, integral and differential operations on the difference between feedback signal of controlled variables and signal of the target, thus forming a negative feedback system to keep the controlled variables above the target. It is suitable for flow control, pressure control, temperature control, etc. Diagram of basic principles for output frequency regulation is shown in the figure below.

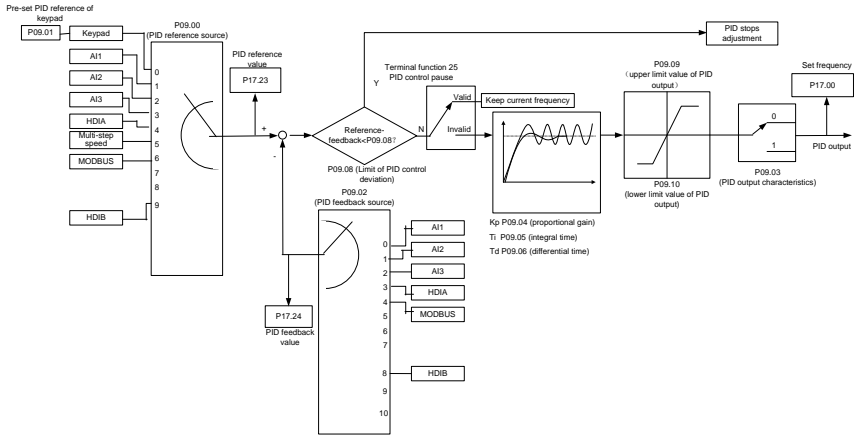

Introduction to the working principles and control methods for PID control

**Proportional control ( $K_p$ ):** When the feedback deviates from the reference, the output will be proportional to the deviation, if such deviation is constant, the regulating variable will also be constant. Proportional control can respond to feedback changes rapidly, however, it cannot eliminate the error by itself. The larger the proportional gain, the faster the regulating speed, but too large gain will result in oscillation. To solve this problem, first, set the integral time to a large value and the derivative time to 0, and run the system by proportional control, and then change the reference to observe the deviation between feedback signal and the reference (static difference), if the static difference is (eg, increase the reference, and the feedback variable is always less than the reference after system stabilizes), continue increasing the proportional gain, otherwise, decrease the proportional gain; repeat such process until the static error becomes small.

**Integral time ( $T_i$ ):** When feedback deviates from reference, the output regulating variable accumulates continuously, if the deviation persists, the regulating variable will increase continuously until deviation disappears. Integral regulator can be used to eliminate static difference; however, too large regulation may lead to repetitive overshoot, which will cause system instability and oscillation. The feature of oscillation caused by strong integral effect is that the feedback signal fluctuates up and down based on the reference variable, and fluctuation range increases gradually until oscillation occurred. Integral time parameter is generally regulated gradually from large to small until the stabilized system speed fulfills the requirement.

**Derivative time ( $T_d$ ):** When the deviation between feedback and reference changes, output the regulating variable which is proportional to the deviation variation rate, and this regulating variable is only related to the direction and magnitude of the deviation variation rather than the direction and magnitude of the deviation itself. Differential control is used to control the feedback signal variation based on the variation trend. Differential regulator should be used with caution as it may easily enlarge the system interferences, especially those with high variation frequency.

When frequency command selection (P00.06, P00.07) is 7, or channel of voltage setup (P04.27) is 6,



the running mode of inverter is process PID control.

### 5.5.13.1 General procedures for PID parameter setup

#### a. Determining proportional gain P

When determining proportional gain P, first, remove the integral term and derivative term of PID by making  $T_i=0$  and  $T_d=0$  (see PID parameter setup for details), thus turning PID into pure proportional control. Set the input to 60%–70% of the max. allowable value, and increase proportional gain P gradually from 0 until system oscillation occurred, and then in turn, decrease proportional gain P gradually from current value until system oscillation disappears, record the proportional gain P at this point and set the proportional gain P of PID to 60%–70% of current value. This is whole commissioning process of proportional gain P.

#### b. Determine integral time $T_i$

After proportional gain P is determined, set the initial value of a larger integral time  $T_i$ , and decrease  $T_i$  gradually until system oscillation occurred, and then in turn, increase  $T_i$  until system oscillation disappears, record the  $T_i$  at this point, and set the integral time constant  $T_i$  of PID to 150%–180% of current value. This is the commissioning process of integral time constant  $T_i$ .

#### c. Determining derivative time $T_d$

The derivative time  $T_d$  is generally set to 0.

If users need to set  $T_d$  to another value, set in the same way with P and  $T_i$ , namely set  $T_d$  to 30% of the value when there is no oscillation.

d. Empty system load, perform load-carrying joint debugging, and then fine-tune PID parameter until fulfilling the requirement.

### 5.5.13.2 How to fine-tune PID

After setting the parameters controlled by PID, users can fine-tune these parameters by the following means.

**Control overmodulation: When overmodulation occurred, shorten the derivative time ( $T_d$ ) and prolong integral time ( $T_i$ ).**

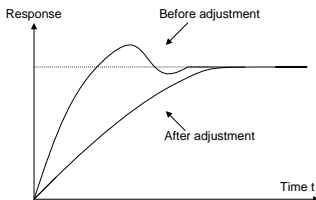

**Stabilize the feedback value as fast as possible:** when overmodulation occurred, shorten integral time ( $T_i$ ) and prolong derivative time ( $T_d$ ) to stabilize control as fast as possible.

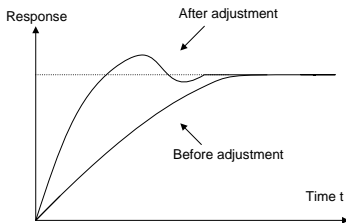

**Control long-term vibration:** If the cycle of periodic vibration is longer than the set value of integral time ( $T_i$ ), it indicates the integral action is too strong, prolong the integral time ( $T_i$ ) to control vibration.

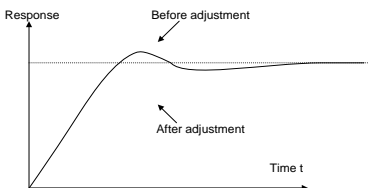

**Control short-term vibration:** If the vibration cycle is short is almost the same with the set value of derivative time ( $T_d$ ), it indicates derivative action is too strong, shorten the derivative time ( $T_d$ ) to control vibration. When derivative time ( $T_d$ ) is set to 0.00 (namely no derivative control), and there is no way to control vibration, decrease the proportional gain.

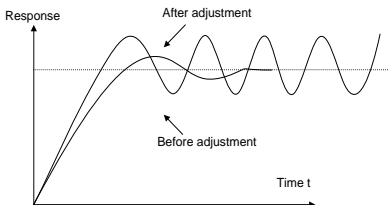

Related parameter list:

Function code	Name	Detailed parameter description	Default value
P09.00	PID reference source	0: Keypad (P09.01) 1: AI1 2: AI2 3: AI3 4: High-speed pulse HDIA 5: Multi-step 6: Modbus communication 7 - 8: Reserved 9: High-speed pulse HDIB 10 - 12: Reserved	0
P09.01	Pre-set PID reference of	-100.0%~100.0%	0.0%

S1 series standard inverter

Function code	Name	Detailed parameter description	Default value
	keypad		
P09.02	PID feedback source	0: AI1 1: AI2 2: AI3 3: High-speed pulse HDIA 4: Modbus communication 5 - 10: Reserved	0
P09.03	PID output characteristics	0: PID output is positive characteristic 1: PID output is negative characteristic	0
P09.04	Proportional gain (Kp)	0.00–100.00	1.80
P09.05	Integral time (Ti)	0.01–10.00s	0.90s
P09.06	Derivative time (Td)	0.00–10.00s	0.00s
P09.07	Sampling cycle (T)	0.000–10.000s	0.100s
P09.08	Limit of PID control deviation	0.0–100.0%	0.0%
P09.09	Upper limit value of PID output	P09.10–100.0% (max. frequency or voltage)	100.0%
P09.10	Lower limit value of PID output	-100.0%–P09.09 (max. frequency or voltage)	0.0%
P09.11	Feedback offline detection value	0.0–100.0%	0.0%
P09.12	Feedback offline detection time	0.0–3600.0s	1.0s
P09.13	PID control selection	0x0000–0x1111 Ones: 0: Continue integral control after the frequency reaches upper/lower limit 1: Stop integral control after the frequency reaches upper/lower limit Tens: 0: The same with the main reference direction 1: Contrary to the main reference direction Hundreds: 0: Limit as per the max. frequency 1: Limit as per A frequency Thousands:	0x0001

Function code	Name	Detailed parameter description	Default value
		0: A+B frequency, acceleration /deceleration of main reference A frequency source buffering is invalid 1: A+B frequency, acceleration/ deceleration of main reference A frequency source buffering is valid, acceleration/deceleration is determined by P08.04 (acceleration time 4).	
P17.00	Set frequency	0.00Hz–P00.03 (Max. output frequency)	0.00Hz
P17.23	PID reference value	-100.0–100.0%	0.0%
P17.24	PID feedback value	-100.0–100.0%	0.0%

**5.5.14 Run at wobbling frequency**

Wobbling frequency is mainly applied in cases where transverse movement and winding functions are needed like textile and chemical fiber industries. The typical working process is shown as below.

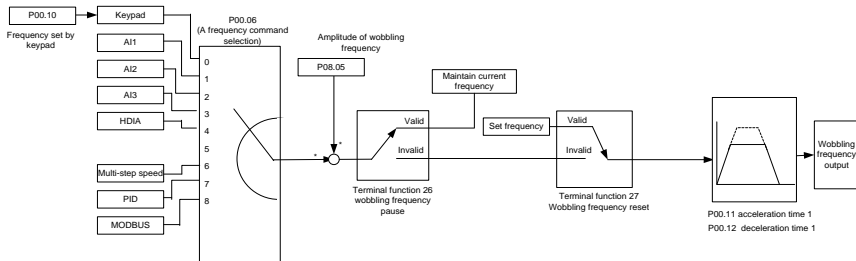

Function code	Name	Detailed parameter description	Default value
P00.03	Max. output frequency	P00.03–400.00Hz	50.00Hz
P00.06	A frequency command selection	0: Set via keypad 1: Set via AI1 2: Set via AI2 3: Set via AI3 4: Set via high speed pulse HDIA 5: Reserved 6: Set via multi-step speed running 7: Set via PID control 8: Set via Modbus communication 9-14: Reserved Note: for models 4kW and above	2

S1 series standard inverter

Function code	Name	Detailed parameter description	Default value
		1: No function 2: AI1 3: AI2	
P00.11	Acceleration time 1	0.0–3600.0s	Depend on model
P00.12	Deceleration time 1	0.0–3600.0s	Depend on model
P05.01– P05.06	Digital input function selection	26: Wobbling frequency pause (stop at current frequency) 27: Wobbling frequency reset (revert to center frequency)	/
P08.15	Amplitude of wobbling frequency	0.0–100.0% (relative to set frequency)	0.0%
P08.16	Amplitude of jump frequency	0.0–50.0% (relative to amplitude of wobbling frequency)	0.0%
P08.17	Rise time of wobbling frequency	0.1–3600.0s	5.0s
P08.18	Descend time of wobbling frequency	0.1–3600.0s	5.0s

**5.5.15 Fault handling**

S1 series inverter provides abundant information concerning fault handling for the convenience of the users.

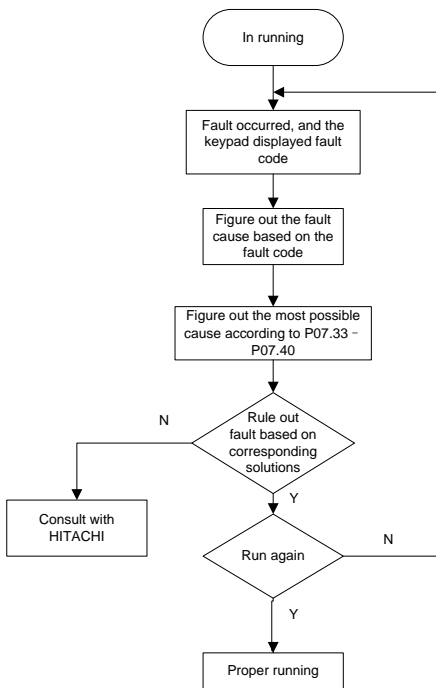

Related parameter list:

Function code	Name	Detailed parameter description	Default value
P07.27	Type of present fault	0: No fault	0
P07.28	Type of the last fault	1: Inverter unit U phase protection (OUt1)	/
P07.29	Type of the last but one fault	2: Inverter unit V phase protection (OUt2)	/
P07.30	Type of the last but two fault	3: Inverter unit W phase protection (OUt3)	/
P07.31	Type of the last but three fault	4: Overcurrent during acceleration (OC1)	/
P07.32	Type of the last but four fault	5: Overcurrent during deceleration (OC2)	
		6: Overcurrent during constant speed (OC3)	
		7: Overvoltage during acceleration (OV1)	
		8: Overvoltage during deceleration (OV2)	
		9: Overvoltage during constant speed	

S1 series standard inverter

Function code	Name	Detailed parameter description	Default value
		(OV3) 10: Bus undervoltage fault (UV) 11: Motor overload (OL1) 12: Inverter overload (OL2) 13: Phase loss on input side (SPI) 14: Phase loss on output side (SPO) 15: Rectifier module overheat (OH1) 16: Inverter module overheat (OH2) 17: External fault (EF) 18: 485 communication fault (CE) 19: Current detection fault (ItE) 20: Motor autotuning fault (tE) 21: EEPROM operation fault (EEP) 22: PID feedback offline fault (PIDE) 23: Brake unit fault (bCE) 24: Running time reached (END) 25: Electronic overload (OL3) 26: Keypad communication error (PCE) 27: Parameter upload error (UPE) 28: Parameter download error (DNE) 29-31: Reserved 32: To-ground short-circuit fault 1 (ETH1) 33: To-ground short-circuit fault 2 (ETH2) 34: Speed deviation fault (dEu) 35: Mal-adjustment fault (STo) 36: Underload fault (LL) 37: Safe torque off (STO) 38: Channel H1 safety circuit exception (STL1) 39: Channel H2 safety circuit exception (STL2) 40: Channel H1 and H2 exception (STL3) 41: Safety code FLASH CRC check fault (CrCE)	
P07.33	Running frequency of present fault		0.00Hz
P07.34	Ramps reference frequency of present fault		0.00Hz
P07.35	Output voltage of present fault		0V
P07.36	Output current of present fault		0.0A
P07.37	Bus voltage of present fault		0.0V

S1 series standard inverter

Function code	Name	Detailed parameter description	Default value
P07.38	Max. temperature of present fault		0.0°C
P07.39	Input terminal state of present fault		0
P07.40	Output terminal state of present fault		0
P07.41	Running frequency of the last fault		0.00Hz
P07.42	Ramps reference frequency of the last fault		0.00Hz
P07.43	Output voltage of the last fault		0V
P07.44	Output current of the last fault		0.0A
P07.45	Bus voltage of the last fault		0.0V
P07.46	Max. temperature of the last fault		0.0°C
P07.47	Input terminal state of the last fault		0
P07.48	Output terminal state of the last fault		0
P07.49	Running frequency of the last but one fault		0.00Hz
P07.50	Ramps reference frequency of the last but one fault		0.00Hz
P07.51	Output voltage of the last but one fault		0V
P07.52	Output current of the last but one fault		0.0A
P07.53	Bus voltage of the last but one fault		0.0V
P07.54	Max. temperature of the last but one fault		0.0°C
P07.55	Input terminal state of the last but one fault		0
P07.56	Output terminal state of the last but one fault		0



## Chapter 6 Function parameter list

### 6.1 What this chapter contains

This chapter lists all the function codes and corresponding description of each function code.

### 6.2 Function parameter list

Function parameters of S1 series inverter are categorized according to functions. Among the function groups, P28 is analog input/output calibration group, and P29 is factory function group which cannot be accessed by users. The function code adopts three-level menu, eg, "P08.08" indicates it is the no. 8 function code in P08 group.

The function group no. corresponds to the first-level menu; function code no. corresponds to the second-level menu; function code parameter corresponds to the third-level menu.

1. The function list is divided into the following columns.

Column 1 "Function code": number of the function parameter group and the parameter;

Column 2 "Name": complete name of the function parameter;

Column 3 "Detailed parameter description": detailed description of this function parameter;

Column 4 "Default value": The original set value of the function parameter by default;

Column 5: "Modify": The modification attribute of the function parameter, namely whether the function parameter can be modified and the condition for modification, as shown below.

"○": the set value of this parameter can be modified when the inverter is in stop or running state;

"◎": the set value of this parameter cannot be modified when the inverter is in running state;

"●": the parameter value is the measured value which cannot be modified.

(The inverter has assigned the modification attribute of each parameter automatically to avoid inadvertent modification by users.)

2. "System of numeration for parameters" is decimal; if the parameter is presented in hexadecimal numbers, the data of each bit will be independent of each other during parameter edit, and the value range of partial bits can be 0–F in hexadecimal system.

3. "Default value" is value restored after parameter refresh during restoring to default value; however, the measured value or recorded value will not be refreshed.

4. In order to enhance parameter protection, the inverter provides password protection for the function codes. After setting user password (namely user password P07.00 is not zero), when users press **PRG/ESC** key to enter function code edit state, the system will first enter user password verification state which displays "0.0.0.0.0.", requiring operators to input the correct user password. For factory parameters, besides user password, it is also required to input the correct factory password (users should not attempt to modify factory parameters as improper setup may easily lead to mal-operation or damage the inverter). When password protection is unlocked, the user password can be modified at any time; user password is subject to the last input. User

password can be cancelled by setting P07.00 to 0; if P07.00 is set to a non-zero value, the parameter will be protected by password. When modifying function parameters through serial communication, the function of user password also follows above rules.

Function code	Name	Detailed parameter description	Default value	Modify
<b>P00 group Basic functions</b>				
P00.00	Speed control mode	1: SVC 1 2: V/F mode <b>Note:</b> If 1 is selected, it is required to carry out motor parameter autotuning first.	2	☉
P00.01	Running command channel	0: Keypad 1: Terminal 2: Communication	1	○
P00.02	Reserved			
P00.03	Max. output frequency	Used to set the maximum output frequency of the inverter. It is the basis of frequency setup and the acceleration/deceleration. Setting range: Max. (P00.04, 10.00) –630.00Hz	50.00Hz	☉
P00.04	Upper limit of running frequency	The upper limit of running frequency is upper limit value of inverter output frequency. This value cannot be more than the maximum output frequency. When the set frequency is higher than the upper limit frequency, the inverter runs at the upper limit frequency. Setting range: P00.05–P00.03 (Max. output frequency)	50.00Hz	☉
P00.05	Lower limit of running frequency	The lower limit of running frequency is the lower limit value of inverter output frequency. When the set frequency is lower than the lower limit frequency, the inverter runs at the lower limit frequency. <b>Note: Max. output frequency ≥ upper limit frequency ≥ lower limit frequency.</b> Setting range: 0.00Hz–P00.04 (upper limit of running frequency)	0.00Hz	☉
P00.06	A frequency command selection	0: Set via keypad 1: Set via A11 2: Set via A12	2	○
P00.07	B frequency	3: Set via A13 (up to 2.2kW)	5	○

S1 series standard inverter

Function code	Name	Detailed parameter description	Default value	Modify
	command selection	4: Set via high speed pulse HDIA 5: Reserved 6: Set via multi-step speed running 7: Set via PID control 8: Set via Modbus communication 9–15: Reserved Note: for models 4kW and above 1: No function 2: AI1 3: AI2		
P00.08	Reference object of B frequency command	0: Max. output frequency 1: A frequency command	0	<input type="radio"/>
P00.09	Combination mode of setting source	0: A 1: B 2: (A+B) 3: (A-B) 4: Max. (A, B) 5: Min. (A, B)	0	<input type="radio"/>
P00.10	Set frequency via keypad	When A and B frequency commands are set by keypad, the value is the initial digital set value of the inverter frequency. Setting range: 0.00 Hz–P00.03 (Max. output frequency)	50.00Hz	<input type="radio"/>
P00.11	Acceleration time 1	Acceleration time is the time needed for accelerating from 0Hz to Max. output frequency (P00.03).	Depend on model	<input type="radio"/>
P00.12	Deceleration time 1	Deceleration time is the time needed from decelerating from Max. output frequency (P00.03) to 0Hz. S1 series inverter defines four groups of acceleration and deceleration time, which can be selected via multi-function digital input terminals (P05 group). The acceleration/deceleration time of the inverter is the first group by default. Setting range of P00.11 and P00.12: 0.0–3600.0s	Depend on model	<input type="radio"/>
P00.13	Running direction	0: Run in default direction 1: Run in reverse direction 2: Reverse running is prohibited	0	<input type="radio"/>

Function code	Name	Detailed parameter description				Default value	Modify																
P00.14	Carrier frequency setup	<table border="1"> <tr> <th>Carrier frequency</th> <th>Electro magnetic noise</th> <th>Noise and leakage current</th> <th>Cooling level</th> </tr> <tr> <td>1kHz</td> <td>↑ High</td> <td>↑ Low</td> <td>↑ Low</td> </tr> <tr> <td>10kHz</td> <td></td> <td></td> <td></td> </tr> <tr> <td>15kHz</td> <td>↓ Low</td> <td>↓ High</td> <td>↓ High</td> </tr> </table>	Carrier frequency	Electro magnetic noise	Noise and leakage current	Cooling level	1kHz	↑ High	↑ Low	↑ Low	10kHz				15kHz	↓ Low	↓ High	↓ High				Depend on model	○
Carrier frequency	Electro magnetic noise	Noise and leakage current	Cooling level																				
1kHz	↑ High	↑ Low	↑ Low																				
10kHz																							
15kHz	↓ Low	↓ High	↓ High																				
The relation between the model and carrier frequency is shown below.		<table border="1"> <thead> <tr> <th colspan="2">Model</th> <th>Default value of carrier frequency</th> </tr> </thead> <tbody> <tr> <td>230V</td> <td>0.4–2.2kW</td> <td>8kHz</td> </tr> <tr> <td rowspan="3">400V</td> <td>0.75–11kW</td> <td>8kHz</td> </tr> <tr> <td>15–55kW</td> <td>4kHz</td> </tr> <tr> <td>Above 75kW</td> <td>2kHz</td> </tr> </tbody> </table>		Model		Default value of carrier frequency	230V	0.4–2.2kW	8kHz	400V	0.75–11kW	8kHz	15–55kW	4kHz	Above 75kW	2kHz	<p>Advantages of high carrier frequency are as follows: ideal current waveform, few current harmonics and small motor noise.</p> <p>Disadvantages of high carrier frequency are as follows: growing switch consumption, enlarged temperature rise, impacted output capacity; under high carrier frequency, the inverter needs to be derated for use, meanwhile, the leakage current will increase, which increases electromagnetic interference to the surroundings.</p> <p>While low carrier frequency is the contrary. Low carrier frequency will cause unstable operation at low frequency, decrease the torque, or even lead to oscillation.</p> <p>If the default carrier frequency is exceeded during use, derating is required, derate by 10% for every additional 1k carrier frequency.</p> <p>Setting range: 1.2–15.0kHz</p>						
Model		Default value of carrier frequency																					
230V	0.4–2.2kW	8kHz																					
400V	0.75–11kW	8kHz																					
	15–55kW	4kHz																					
	Above 75kW	2kHz																					
P00.15	Motor parameter autotuning	0: No operation 1: Rotary autotuning; carry out comprehensive motor parameter autotuning; rotary autotuning is used in cases where high control precision is				0	◎																

S1 series standard inverter

Function code	Name	Detailed parameter description	Default value	Modify
		required; 2: Static autotuning 1 (comprehensive autotuning); static autotuning 1 is used in cases where the motor cannot be disconnected from load; 3: Static autotuning 2 (partial autotuning) ; when current motor is motor 1, only P02.06, P02.07 and P02.08 will be autotuned; when current motor is motor 2, only P12.06, P12.07 and P12.08 will be autotuned.		
P00.16	AVR function	0: Invalid 1: Valid during the whole process Automatic voltage regulation function is used to eliminate the impact on the output voltage of inverter when bus voltage fluctuates.	1	○
P00.17	Inverter type	0: ND; 1: LD;	0	
P00.18	Function parameter restoration	0: No operation 1: Restore to default value 2: Clear fault history Note: After the selected function operations are done, this function code will be restored to 0 automatically. Restoration to default value will clear the user password, this function should be used with caution.	0	◎
<b>P01 group Start/stop control</b>				
P01.00	Running mode of start	0: Direct start 1: Start after DC brake 2: Start after speed-tracking 1 3: Start after speed-tracking 2 <b>Note:</b> This function is only available for the inverters≥4kW	0	◎
P01.01	Starting frequency of direct start	Starting frequency of direct startup is the initial frequency when the inverter starts. See P01.02 (hold time of starting frequency) for details. Setting range: 0.00–50.00Hz	0.50Hz	◎

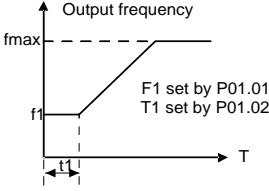
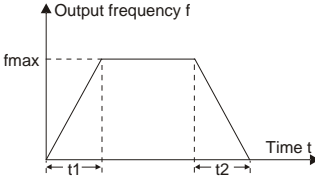
Function code	Name	Detailed parameter description	Default value	Modify
P01.02	Hold time of starting frequency	 <p>A proper starting frequency can increase the torque during startup. Within the hold time of starting frequency, the output frequency of inverter is the starting frequency, and then it runs from the starting frequency to the target frequency, if the target frequency (frequency command) is below the starting frequency, the inverter will be standby rather than running. The starting frequency value is unlimited by the lower limit frequency.</p> <p>Setting range: 0.0–50.0s</p>	0.0s	☉
P01.03	DC brake current before start	<p>During starting, the inverter will first perform DC brake based on the set DC brake current before startup, and then it will accelerate after the set DC brake time before startup elapses. If the set DC brake time is 0, DC brake will be invalid.</p>	0.0%	☉
P01.04	DC brake time before start	<p>The larger the DC brake current, the stronger the brake force. The DC brake current before startup refers to the percentage relative to rated inverter current.</p> <p>Setting range of P01.03: 0.0–100.0% Setting range of P01.04: 0.00–50.00s</p>	0.00s	☉
P01.05	Acceleration/deceleration mode	<p>This function code is used to select the frequency variation mode during starting and running.</p> <p>0: Straight line; the output frequency increases or decreases in straight line;</p>  <p>1: S curve; the output frequency increases or</p>	0	☉

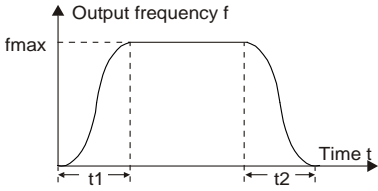
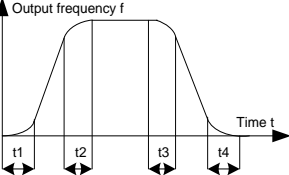
Function code	Name	Detailed parameter description	Default value	Modify
		<p>decreases in S curve; S curve is generally used in cases where smooth start/stop is required, eg, elevator, conveyer belt, etc.</p>  <p><b>Note: When set to 1, it is required to set P01.06, P01.07, P01.27 and P01.28 accordingly.</b></p>		
P01.06	Time of starting section of acceleration S curve	The curvature of S curve is determined by acceleration range and acceleration and deceleration time.	0.1s	☉
P01.07	Time of ending section of acceleration S curve	 <p>t1=P01.06 t2=P01.07 t3=P01.27 t4=P01.28</p> <p>Setting range: 0.0–50.0s</p>	0.1s	☉
P01.08	Stop mode	<p>0: Decelerate to stop; after stop command is valid, the inverter lowers output frequency based on the deceleration mode and the defined deceleration time, after the frequency drops to the stop speed (P01.15), the inverter stops.</p> <p>1: Coast to stop; after stop command is valid, the inverter stops output immediately, and the load coasts to stop as per mechanical inertia.</p>	0	○
P01.09	Starting frequency of DC brake after stop	Starting frequency of DC brake after stop; during decelerating to stop, when this frequency is reached, DC brake will be performed after stop.	0.00Hz	○
P01.10	Waiting time of DC brake after stop	Demagnetization time (waiting time of DC brake after stop): Before the DC brake, the inverter will block output, and after the demagnetization time	0.00s	○
P01.11	DC brake current	elapses, DC brake will start. This function is used	0.0%	○

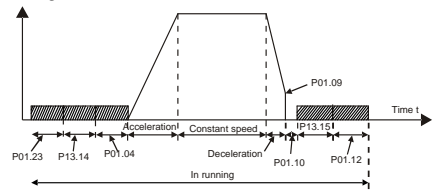
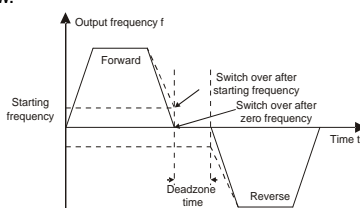
Function code	Name	Detailed parameter description	Default value	Modify
	of stop	to prevent overcurrent fault caused by DC brake during high speed.		
P01.12	DC brake time of stop	<p>DC brake current after stop: it means the DC brake force applied, the larger the current, the stronger the DC brake effect.</p>  <p>Setting range of P01.09: 0.00Hz–P00.03 (Max. output frequency)                      Setting range of P01.10: 0.00–30.00s                      Setting range of P01.11: 0.0–100.0%                      Setting range of P01.12: 0.0–50.0s</p>	0.00s	○
P01.13	Deadzone time of forward/reverse rotation	<p>This function code refers to the transition time of the threshold set by P01.14 during setting forward/reverse rotation of the inverter, as shown below.</p>  <p>Setting range: 0.0–3600.0s</p>	0.0s	○
P01.14	Forward/reverse rotation switch-over mode	0: Switch over after zero frequency 1: Switch over after starting frequency 2: Switch over after passing stop speed and delay	0	◎
P01.15	Stop speed	0.00–100.00Hz	0.50Hz	◎
P01.16	Stop speed detection mode	0: Set value of speed (the only detection mode valid in V/F mode) 1: Detection value of speed	0	◎
P01.17	Stop speed detection time	0.00–100.00s	0.50s	◎
P01.18	Running protection of	When the running command channel is controlled by terminals, the system will detect running	0	○



S1 series standard inverter

Function code	Name	Detailed parameter description	Default value	Modify
	power-on terminal	terminal state automatically during power up. 0: Terminal running command is invalid during power up. The inverter will not run during power up even if the running command terminal is detected to be valid, and the system is in running protection state. The inverter will run only after this terminal is cancelled and enabled again. 1: Terminal running command is valid during power up. The system will start the inverter automatically after initialization is done if the running command terminal is detected to be valid during power up. Note: This function must be set with caution, otherwise, serious consequences may occur.		
P01.19	Action selection when the running frequency is below lower limit (lower limit should be larger than 0)	This function code is used to set the running state of inverter when the set frequency is below lower limit frequency. 0: Run in lower limit of the frequency 1: Stop 2: Sleep When the set frequency is below lower limit frequency, the inverter coasts to stop; when the set frequency is above lower limit again and continues to be so after the time set by P01.20 elapses, the inverter will be restored to running state automatically.	0	⊙
P01.20	Wake-up-from-sleep delay	This function code is used to set the sleep delay. When the running frequency of inverter is below the lower limit frequency, the inverter enters sleep state; when the set frequency is above the lower limit again and continues to be so after the time set by P01.20 elapses, the inverter will run automatically.	0.0s	○

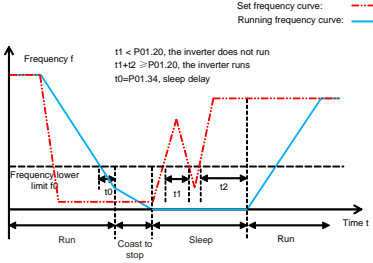
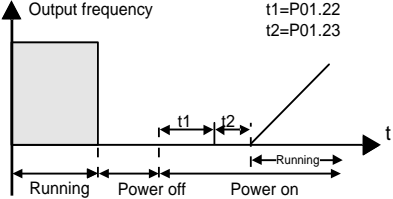
Function code	Name	Detailed parameter description	Default value	Modify
		 <p>Setting range: 0.0–3600.0s (valid when P.01.19 is 2)</p>		
P01.21	Restart after power down	<p>This function code sets the automatic running of the inverter at next power-on after power down.</p> <p>0: Disabled restart 1: Enable restart, namely the inverter will run automatically after the time set by P01.22 elapses if the starting conditions are met.</p>	0	○
P01.22	Waiting time of restart after power down	<p>This function code sets the waiting time before automatically running at next power-on after power down.</p>  <p>Setting range: 0.0–3600.0s (valid when P01.21 is 1)</p>	1.0s	○
P01.23	Start delay	<p>This function code sets the delay of the inverter's wake-up-from-sleep after running command is given, the inverter will start to run and output after the time set by P01.23 elapses to realize brake release.</p> <p>Setting range: 0.0–600.0s</p>	0.0s	○
P01.24	Stop speed delay	0.0–600.0s	0.0s	○
P01.25	Open-loop 0Hz output selection	<p>0: No voltage output 1: With voltage output 2: Output as per DC brake current of stop</p>	0	○

S1 series standard inverter

Function code	Name	Detailed parameter description	Default value	Modify
P01.26	Deceleration time of emergency-stop	0.0–60.0s	2.0s	○
P01.27	Time of starting section of deceleration S curve	0.0–50.0s	0.1s	◎
P01.28	Time of ending section of deceleration S curve	0.0–50.0s	0.1s	◎
P01.29	Short-circuit brake current	When the inverter starts in direct start mode (P01.00=0), set P01.30 to a non-zero value to enter short-circuit brake. During stop, if the running frequency of inverter is below the starting frequency of brake after stop, set P01.31 to a non-zero value to enter short-circuit brake after stop, and then carry out DC brake in the time set by P01.12 (refer to P01.09–P01.12). Setting range of P01.29: 0.0–150.0% (inverter) Setting range of P01.30: 0.0–50.0s Setting range of P01.31: 0.0–50.0s	0.0%	○
P01.30	Hold time of short-circuit brake at startup		0.00s	○
P01.31	Hold time of short-circuit brake at stop		0.00s	○
<b>P02 group Parameters of motor 1</b>				
P02.01	Rated power of asynchronous motor 1	0.1–3000.0kW	Depend on model	◎
P02.02	Rated frequency of asynchronous motor 1	0.01Hz–P00.03 (Max. output frequency)	50.00Hz	◎
P02.03	Rated speed of asynchronous motor 1	1–36000rpm	Depend on model	◎
P02.04	Rated voltage of asynchronous motor 1	0–1200V	Depend on model	◎
P02.05	Rated current of asynchronous	0.8–6000.0A	Depend on	◎

S1 series standard inverter

Function code	Name	Detailed parameter description	Default value	Modify
	motor 1		model	
P02.06	Stator resistance of asynchronous motor 1	0.001–65.535Ω	Depend on model	<input type="radio"/>
P02.07	Rotor resistance of asynchronous motor 1	0.001–65.535Ω	Depend on model	<input type="radio"/>
P02.08	Leakage inductance of asynchronous motor 1	0.1–6553.5Mh	Depend on model	<input type="radio"/>
P02.09	Mutual inductance of asynchronous motor 1	0.1–6553.5Mh	Depend on model	<input type="radio"/>
P02.10	No-load current of asynchronous motor 1	0.1–6553.5A	Depend on model	<input type="radio"/>
P02.11	Magnetic saturation coefficient 1 of iron core of asynchronous motor 1	0.0–100.0%	80.0%	<input type="radio"/>
P02.12	Magnetic saturation coefficient 2 of iron core of asynchronous motor 1	0.0–100.0%	68.0%	<input type="radio"/>
P02.13	Magnetic saturation coefficient 3 of iron core of asynchronous motor 1	0.0–100.0%	57.0%	<input type="radio"/>
P02.14	Magnetic saturation	0.0–100.0%	40.0%	<input type="radio"/>

Function code	Name	Detailed parameter description	Default value	Modify
	coefficient 4 of iron core of asynchronous motor 1			
P02.26	Overload protection of motor 1	<p>0: No protection</p> <p>1: Common motor (with low-speed compensation). As the cooling effect of common motor will be degraded in low speed, the corresponding electronic thermal protection value should also be adjusted properly, the low compensation here means to lower the overload protection threshold of the motor whose running frequency is below 30Hz.</p> <p>2: Frequency-variable motor (without low speed compensation). As the cooling effect of frequency-variable motor is not affected by the rotating speed, there is no need to adjust the protection value during low speed running.</p>	2	⊙
P02.27	Overload protection coefficient of motor 1	<p>Motor overload multiples <math>M = I_{out} / (I_n \times K)</math></p> <p><math>I_n</math> is rated motor current, <math>I_{out}</math> is inverter output current, <math>K</math> is motor overload protection coefficient. The smaller the <math>K</math>, the larger the value of <math>M</math>, and the easier the protection.</p> <p><math>M=116\%</math>: protection will be applied when motor overloads for 1h; <math>M=200\%</math>: protection will be applied when motor overloads for 60s; <math>M \geq 400\%</math>: protection will be applied immediately.</p> <p>Setting range: 20.0%–120.0%</p>	100.0%	○
P02.28	Power display calibration coefficient of motor 1	<p>This function adjusts the power display value of motor 1 only, and it does not affect the control performance of the inverter.</p> <p>Setting range: 0.00–3.00</p>	1.00	○

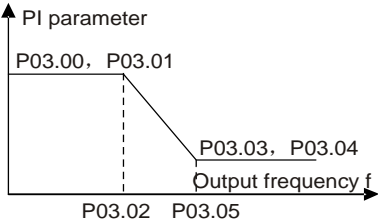
Function code	Name	Detailed parameter description	Default value	Modify
<b>P03 group Vector control of motor</b>				
P03.00	Speed loop proportional gain 1	Parameters of P03.00–P03.05 fit for vector control mode only. Below P03.02, speed loop PI parameter is P03.00 and P03.01; above P03.06, speed loop PI parameter is P03.03 and P03.04; in between, PI parameter is obtained by linear variation between two groups of parameters, as shown below. 	20.0	○
P03.01	Speed loop integral time 1		0.200s	○
P03.02	Switch low point frequency		5.00Hz	○
P03.03	Speed loop proportional gain 2		20.0	○
P03.04	Speed loop integral time 2		0.200s	○
P03.05	Switch over high point frequency	The speed loop dynamic response characteristics of vector control can be adjusted by setting the proportional coefficient and integral time of speed regulator. Increase proportional gain or decrease integral time can accelerate dynamic response of speed loop, however, if the proportional gain is too large or integral time is too small, system oscillation and overshoot may occur; if proportional gain is too small, stable oscillation or speed offset may occur. Speed loop PI parameter is closely related to the system inertial, users should make adjustment based on default PI parameter according to different load characteristics to fulfill different needs. Setting range of P03.00:0.0–200.0; Setting range of P03.01: 0.000–10.000s Setting range of P03.02: 0.00Hz–P03.05 Setting range of P03.03: 0.0–200.0 Setting range of P03.04: 0.000–10.000s Setting range of P03.05: P03.02–P00.03 (Max. output frequency)	10.00Hz	○
P03.06	Speed loop	0–8 (corresponds to $0-2^{18}/10\text{ms}$ )	0	○

S1 series standard inverter

Function code	Name	Detailed parameter description	Default value	Modify
	output filter			
P03.07	Vector control slip compensation coefficient (motoring)	Slip compensation coefficient is used to adjust the slip frequency of vector control to improve speed control precision. This parameter can be used to control speed offset. Setting range: 50–200%	100%	<input type="radio"/>
P03.08	Vector control slip compensation coefficient (generating)		100%	<input type="radio"/>
P03.09	Current loop proportional coefficient P	<b>Note:</b> These two parameters are used to adjust PI parameters of current loop; it affects dynamic response speed and control precision of the system directly. The default value needs no adjustment under common conditions. Setting range: 0–65535	1000	<input type="radio"/>
P03.10	Current loop integral coefficient I		1000	<input type="radio"/>
P03.11	Torque setup mode selection	0: Torque control invalid 1: Set via keypad (P03.12) 2: Set via AI1 3: Set via AI2 4: Set via AI3 (up to 2.2kW) 5: Set via pulse frequency HDI/HDIA 6: Set via multi-step torque 7: Set via Modbus communication 8 - 12: Reserved <b>Note:</b> Source 2-7, 100% corresponds to three times of rated motor current	0	<input type="radio"/>
P03.12	Torque set by keypad	-300.0%–300.0% (rated motor current)	20.0%	<input type="radio"/>
P03.13	Torque reference filter time	0.000–10.000s	0.010s	<input type="radio"/>
P03.14	Source of upper limit frequency setup of forward rotation in torque control	0: Keypad (P03.16) 1: AI1 2: AI2 3: AI3 (up to 2.2kW) 4: Pulse frequency HDI/HDIA 5: Multi-step 6: Modbus communication 7 - 12: Reserved	0	<input type="radio"/>

S1 series standard inverter

Function code	Name	Detailed parameter description	Default value	Modify
		<b>Note:</b> Source 1-6, 100% relative to the max. frequency		
P03.15	Source of upper limit frequency setup of reverse rotation in torque control	0: Keypad (P03.17) 1: AI1 2: AI2 3: AI3 (up to 2.2kW) 4: Pulse frequency HDI/HDIA 5: Multi-step 6: Modbus communication 7 - 12: Reserved <b>Note:</b> Source 1-6, 100% relative to the max. frequency	0	○
P03.16	Keypad limit value of upper limit frequency of forward rotation in torque control	This function code is used to set frequency limit. 100% corresponds to the max. frequency. P03.16 sets the value when P03.14=1; P03.17 sets the value when P03.15=1.	50.00Hz	○
P03.17	Max. output frequency	Setting range: 0.00Hz–P00.03 (Max. output frequency)	50.00Hz	○
P03.18	Source of upper limit setup of the torque during motoring	0: Keypad (P03.20) 1: AI1 2: AI2 3: AI3 (up to 2.2kW) 4: Pulse frequency HDI/HDIA 5: Modbus communication 6 - 11: Reserved <b>Note:</b> Source 1-5, 100% corresponds to three times of rated motor current	0	○
P03.19	Source of upper limit setup of brake torque	0: Keypad (P03.21) 1: AI1 2: AI2 3: AI3 (up to 2.2kW) 4: Pulse frequency HDI/HDIA 5: Modbus communication 6 - 11: Reserved <b>Note:</b> Source 1-5, 100% corresponds to three times of rated motor current.	0	○
P03.20	Set upper limit of the torque when	This function code is used to set torque limit. Setting range: 0.0–300.0% (rated motor current)	180.0%	○

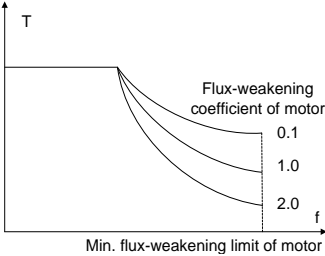

Function code	Name	Detailed parameter description	Default value	Modify
	motoring via keypad			
P03.21	Set upper limit of brake torque via keypad		180.0%	<input type="radio"/>
P03.22	Flux-weakening coefficient of constant-power zone	Used when asynchronous motor is in flux-weakening control.	0.3	<input type="radio"/>
P03.23	Min. flux-weakening point of constant-power zone	 <p>P03.22 and P03.23 are valid during constant power. When motor speed is above rated speed, motor enters flux-weakening running state. The flux-weakening control coefficient can change the flux-weakening curvature, the larger the coefficient, the steeper the curve, the smaller the coefficient, the smoother the curve.</p> <p>Setting range of P03.22: 0.1–2.0 Setting range of P03.23: 10%–100%</p>	20%	<input type="radio"/>
P03.24	Max. voltage limit	P03.24 sets the maximum output voltage of the inverter, which is the percentage of rated motor voltage. This value should be set according to field conditions.	100.0%	<input type="radio"/>
P03.25	Pre-exciting time	Carry out motor pre-exciting during starting to build a magnetic field inside the motor to improve the torque characteristics of motor during starting.	0.300s	<input type="radio"/>
P03.26	Flux-weakening proportional gain	0–8000	1000	<input type="radio"/>
P03.27	Vector control speed display	0: Display as per actual value 1: Display as per the set value	0	<input type="radio"/>
P03.28	Static friction compensation	0.0–100.0%	0.0%	<input type="radio"/>

Function code	Name	Detailed parameter description	Default value	Modify
	coefficient			
P03.29	Corresponding frequency point of static friction	0.50– P03.31	1.00Hz	○
<b>P04 group V/F control</b>				
P04.00	V/F curve setup of motor 1	<p>This group of function code defines the V/F curve of motor 1 to satisfy different load characteristics needs.</p> <p>0: Straight V/F curve; fit for constant-torque load                      1: Multi-point V/F curve                      2: Torque down V/F curve (1.3<sup>th</sup> order)                      3: Torque down V/F curve (1.7<sup>th</sup> order)                      4: Torque down V/F curve (2.0<sup>nd</sup> order)</p> <p>Curve 2–4 are suitable for torque-variable load of fan pump and similar equipment. Users can make adjustment based on load characteristics to achieve optimal energy-saving effect.</p> <p>5: Customized V/F (V/F separation); under this mode, V is separated from f. Users can adjust f through the frequency reference channel set by P00.06 to change the curve characteristic, or adjust V through the voltage reference channel set by P04.27 to change the curve characteristics.</p> <p><b>Note: The <math>V_b</math></b> in the figure below corresponds to rated motor voltage, and <math>f_b</math> corresponds to rated motor frequency.</p>	0	◎
P04.01	Torque boost of motor 1	In order to compensate for low-frequency torque characteristics, users can make some boost compensation to the output voltage. P04.01 is relative to the maximum output voltage $V_b$ .	0.0%	○
P04.02	Motor 1 torque boost cut-off	P04.02 defines the percentage of cut-off frequency of manual torque boost to the rated motor frequency $f_b$ . Torque boost can improve the low-frequency torque characteristics of V/F.	20.0%	○

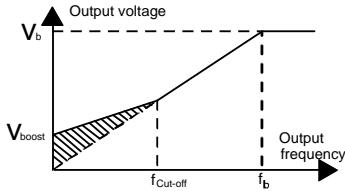
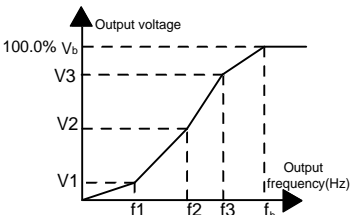
Function code	Name	Detailed parameter description	Default value	Modify
		<p>Users should select torque boost based on the load, eg, larger load requires larger torque boost, however, if the torque boost is too large, the motor will run at over-excitation, which will cause increased output current and motor heat-up, thus degrading the efficiency.</p> <p>When torque boost is set to 0.0%, the inverter is automatic torque boost.</p> <p>Torque boost cut-off threshold: Below this frequency threshold, the torque boost is valid, exceeding this threshold invalidates torque boost.</p>  <p>Setting range of P04.01: 0.0%: (automatic) 0.1%–10.0%</p> <p>Setting range of P04.02: 0.0%–50.0%</p>		
P04.03	V/F frequency point 1 of motor 1	When P04.00 =1 (multi-point V/F curve), users can set V/F curve via P04.03–P04.08.	0.00Hz	<input type="radio"/>
P04.04	V/F voltage point 1 of motor 1	V/F curve is usually set according to the characteristics of motor load.	00.0%	<input type="radio"/>
P04.05	V/F frequency point 2 of motor 1	<b>Note:</b> $V_1 < V_2 < V_3$ , $f_1 < f_2 < f_3$ . If low-frequency voltage is set too high, motor overheat or burnt-down may occur, and overcurrent stall or overcurrent protection may occur to the inverter.	0.00Hz	<input type="radio"/>
P04.06	V/F voltage point 2 of motor 1		0.0%	<input type="radio"/>
P04.07	V/F frequency point 3 of motor 1		0.00Hz	<input type="radio"/>
P04.08	V/F voltage point 3 of motor 1	 <p>Setting range of P04.03: 0.00Hz–P04.05</p> <p>Setting range of P04.04: 0.0%–110.0% (rated voltage of motor 1)</p>	00.0%	<input type="radio"/>

S1 series standard inverter

Function code	Name	Detailed parameter description	Default value	Modify
		Setting range of P04.05: P04.03–P04.07 Setting range of P04.06: 0.0%–110.0% (rated voltage of motor 1) Setting range of P04.07: P04.05–P02.02 (rated frequency of asynchronous motor 1) Setting range of P04.08: 0.0%–110.0% (rated voltage of motor 1)		
P04.09	V/F slip compensation gain of motor 1	This parameter is used to compensate for the motor rotating speed change caused by load change in the V/F mode, and thus improve the rigidity of the mechanical characteristics of the motor. You need to calculate the rated slip frequency of the motor as follows: $\Delta f = f_b - n \times p / 60$ where $f_b$ is the rated frequency of motor 1, corresponding to P02.02; $n$ is the rated speed of motor 1, corresponding to P02.03; $p$ is the number of pole pairs of motor 1. 100% corresponds to the rated slip frequency $\Delta f$ of motor 1. Setting range: 0.0–200.0%	100.0%	○
P04.10	Low-frequency oscillation control factor of motor 1	Under V/F control mode, the motor, especially the large-power motor may experience current oscillation during certain frequencies, which may lead to unstable motor operation, or even inverter overcurrent, users can adjust these two parameters properly to eliminate such phenomenon.	10	○
P04.11	High-frequency oscillation control factor of motor 1		10	○
P04.12	Oscillation control threshold of motor 1		30.00Hz	○
P04.13	V/F curve setup of motor 2	This parameter defines the V/F curve of motor 2 of the S1 series to meet various load characteristic requirements. 0: Straight V/F curve; 1: Multi-point V/F curve 2: Torque-down V/F curve (1.3 <sup>th</sup> order) 3: Torque-down V/F curve (1.7 <sup>th</sup> order)	0	◎

S1 series standard inverter

Function code	Name	Detailed parameter description	Default value	Modify
		4: Torque-down V/F curve (2.0 <sup>nd</sup> order) 5: Customize V/F (V/F separation)		
P04.14	Torque boost of motor 2	<b>Note:</b> Refer to the parameter description of P04.01 and P04.02.	0.0%	<input type="radio"/>
P04.15	Motor 2 torque boost cut-off	Setting range of P04.14: 0.0%: (automatic) 0.1%–10.0% Setting range of 0.0%–50.0% (relative to rated frequency of motor 2).	20.0%	<input type="radio"/>
P04.16	V/F frequency point 1 of motor 2	<b>Note:</b> Refer to the parameter description of P04.03–P04.08.	0.00Hz	<input type="radio"/>
P04.17	V/F voltage point 1 of motor 2	Setting range of P04.16: 0.00Hz–P04.18 Setting range of P04.17:0.0%–110.0% (rated voltage of motor 2)	00.0%	<input type="radio"/>
P04.18	V/F frequency point 2 of motor 2	Setting range of P04.18: P04.16–P04.20	0.00Hz	<input type="radio"/>
P04.19	V/F voltage point 2 of motor 2	Setting range of P04.19: 0.0%–110.0% (rated voltage of motor 2)	00.0%	<input type="radio"/>
P04.20	V/F frequency point 3 of motor 2	Setting range of P04.20: P04.18–P12.02 (rated frequency of asynchronous motor 2) or P04.18–P12.16 (rated frequency of synchronous motor 2)	0.00Hz	<input type="radio"/>
P04.21	V/F voltage point 3 of motor 2	Setting range of P04.21:0.0%–110.0%(rated voltage of motor 2)	00.0%	<input type="radio"/>
P04.22	V/F slip compensation gain of motor 2	This parameter is used to compensate for the motor rotating speed change caused by load change in the V/F mode, and thus improve the rigidity of the mechanical characteristics of the motor. You need to calculate the rated slip frequency of the motor as follows: $\Delta f = f_b - n \cdot p / 60$ where $f_b$ is the rated frequency of motor 2, corresponding to P12.02; $n$ is the rated speed of motor 2, corresponding to P12.03; $p$ is the number of pole pairs of motor 2. 100% corresponds to the rated slip frequency $\Delta f$ of motor 2. Setting range: 0.0–200.0%	100.0%	<input type="radio"/>
P04.23	Low-frequency oscillation control factor of motor 2	In the V/F mode, current oscillation may easily occur on motors, especially large-power motors, at some frequency, which may cause unstable	10	<input type="radio"/>
P04.24	High-frequency	running of motors or even overcurrent of inverters.	10	<input type="radio"/>

S1 series standard inverter

Function code	Name	Detailed parameter description	Default value	Modify
	oscillation control factor of motor 2	You can modify this parameter to prevent current oscillation.		
P04.25	Oscillation control threshold of motor 2	Setting range of P04.23: 0–100 Setting range of P04.24: 0–100 Setting range of P04.25: 0.00 Hz–P00.03 (Max. output frequency)	30.00Hz	○
P04.26	Energy-saving run	0: No action 1: Automatic energy-saving operation Under light-load state, the motor can adjust the output voltage automatically to achieve energy-saving purpose	0	◎
P04.27	Channel of voltage setup	0: Keypad; output voltage is determined by P04.28 1: AI1 2: AI2 3: AI3 (up to 2.2kW) 4: HDI/HDIA 5: Multi-step (the set value is determined by P10 group) 6: PID 7: Modbus communication 8 - 13: Reserved	0	○
P04.28	Set voltage value via keypad	When the channel for voltage setup is set to "keypad", the value of this function code is digital voltage set value. Setting range: 0.0%–100.0%	100.0%	○
P04.29	Voltage increase time	Voltage increase time means the time needed from outputting the min. voltage to accelerating to output the max. voltage.	5.0s	○
P04.30	Voltage decrease time	Voltage decrease time means the time needed from outputting max. voltage to outputting the min. voltage Setting range: 0.0–3600.0s	5.0s	○
P04.31	Output max. voltage	Set the upper/lower limit value of output voltage.	100.0%	◎
P04.32	Output min. voltage		0.0%	◎

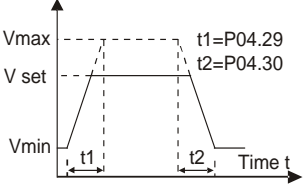
Function code	Name	Detailed parameter description	Default value	Modify
		 <p>Setting range of P04.31: P04.32–100.0% (rated motor voltage) Setting range of P04.32: 0.0%–P04.31</p>		
P04.33	Flux-weakening coefficient in the constant power zone	1.00–1.30	1.00	<input type="radio"/>
P04.34	Enable/disable IF mode for asynchronous motor	0: Disabled 1: Enabled	0	<input checked="" type="radio"/>
P04.35	Current setting in IF mode for asynchronous motor	When IF control is adopted for asynchronous motor 1, this parameter is used to set the output current. The value is a percentage in relative to the rated current of the motor. Setting range: 0.0–200.0%	120.0%	<input type="radio"/>
P04.36	Proportional coefficient in IF mode for asynchronous motor	When IF control is adopted for asynchronous motor 1, this parameter is used to set the proportional coefficient of the output current closed-loop control. Setting range: 0–5000	350	<input type="radio"/>
P04.37	Integral coefficient in IF mode for asynchronous motor	When IF control is adopted for asynchronous motor 1, this parameter is used to set the inetgral coefficient of the output current closed-loop control. Setting range: 0–5000	150	<input type="radio"/>
P04.38	Frequency threshold for switching off IF mode for asynchronous motor 1	When IF control is adopted for asynchronous motor 1, this parameter is used to set the frequency threshold for switching off the output current closed-loop control. When the frequency is lower than the value of this parameter, the current closed-loop control in the IF control mode is enabled; and when the frequency is higher than	10.00Hz	<input type="radio"/>

S1 series standard inverter

Function code	Name	Detailed parameter description	Default value	Modify
		that, the current closed-loop control in the IF control mode is disabled. Setting range: 0.00–20.00 Hz		
<b>P05 group Input terminals</b>				
P05.00	HDI input type	0x00–0x11 Ones: HDIA input type 0: HDIA is high-speed pulse input 1: HDIA is digital input Tens: HDIB input type 0: HDIB is high-speed pulse input 1: HDIB is digital input Note: up to 2.2kW only there is 1 channel HDI.	0	⊙
P05.01	Function of S1 terminal	0: No function 1: Forward running	1	⊙
P05.02	Function of S2 terminal	2: Reverse running 3: 3-wire control/Sin	4	⊙
P05.03	Function of S3 terminal	4: Forward jogging 5: Reverse jogging	7	⊙
P05.04	Function of S4 terminal	6: Coast to stop 7: Fault reset	0	⊙
P05.05	Function of HDI/HDIA terminal	8: Running pause 9: External fault input 10: Frequency increase (UP) 11: Frequency decrease (DOWN)	0	⊙
P05.06	Function of HDIB terminal	12: Clear frequency increase/decrease setting 13: Switch-over between setup A and setup B 14: Switch-over between combination setting and A setting 15: Switch-over between combination setting and setup B 16: Multi-step speed terminal 1 17: Multi-step speed terminal 2 18: Multi-step speed terminal 3 19: Multi-step speed terminal 4 20: Multi-step speed pause 21: Acceleration/deceleration time selection 1 22: Acceleration/deceleration time selection 2 23 – 24: Reserved 25: PID control pause	0	⊙



S1 series standard inverter

Function code	Name	Detailed parameter description	Default value	Modify
		26: Wobbling frequency pause 27: Wobbling frequency reset 28: Counter reset 29: Switching between speed control and torque control 30: Acceleration/deceleration disabled 31: Counter trigger 32: Reserved 33: Clear frequency increase/decrease setting temporarily 34: DC brake 35: Switching between motor 1 and motor 2 36: Command switches to keypad 37: Command switches to terminal 38: Command switches to communication 39: Pre-exciting command 40: Zero out power consumption quantity 41: Maintain power consumption quantity 42: Emergency stop 43 - 60: Reserved 61: PID polarity switch-over 62-79: Reserved		
P05.07	Reserved variables	0-65535	0	●
P05.08	Polarity of input terminal	This function code is used to set the polarity of input terminals. When the bit is set to 0, input terminal polarity is positive; When the bit is set to 1, input terminal polarity is negative; 0x000-0x3F	0x000	○
P05.09	Digital filter time	Set the sampling filtering time of the S1-S4, HDIA, and .HDIB terminals. In cases where interference is strong, increase the value of this parameter to avoid mal-operation. 0.000-1.000s	0.010s	○
P05.10	Virtual terminal setting	0x000-0x3F (0: disable, 1: enable) BIT0: S1 virtual terminal BIT1: S2 virtual terminal	0x00	◎

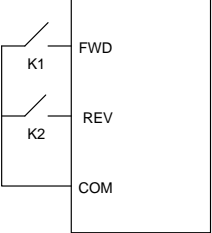
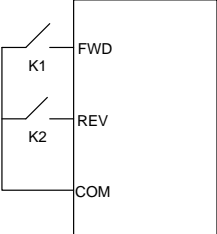
Function code	Name	Detailed parameter description	Default value	Modify																														
		BIT2: S3 virtual terminal BIT3: S4 virtual terminal BIT4: HDI/HDIA virtual terminal BIT5: HDIB virtual terminal																																
P05.11	2/3 Wire control mode	<p>This function code is used to set the 2/3 Wire control mode.</p> <p>0: 2-Wire control 1; integrate enabling function with direction. This mode is the most popular dual-line mode. Direction of motor rotation is determined by the defined FWD/REV terminal command.</p> <div style="display: flex; align-items: center;">  <table border="1" style="margin-left: 20px;"> <thead> <tr> <th>FWD</th> <th>REV</th> <th>Running command</th> </tr> </thead> <tbody> <tr> <td>OFF</td> <td>OFF</td> <td>Stop</td> </tr> <tr> <td>ON</td> <td>OFF</td> <td>Forward running</td> </tr> <tr> <td>OFF</td> <td>ON</td> <td>Reverse running</td> </tr> <tr> <td>ON</td> <td>ON</td> <td>Hold</td> </tr> </tbody> </table> </div> <p>1: 2-wire control 2; separate enabling function with direction. In this mode, the defined FWD is enabling terminal, and the direction is determined by the state of REV.</p> <div style="display: flex; align-items: center;">  <table border="1" style="margin-left: 20px;"> <thead> <tr> <th>FWD</th> <th>REV</th> <th>Running command</th> </tr> </thead> <tbody> <tr> <td>OFF</td> <td>OFF</td> <td>Stop</td> </tr> <tr> <td>ON</td> <td>OFF</td> <td>Forward running</td> </tr> <tr> <td>OFF</td> <td>ON</td> <td>Stop</td> </tr> <tr> <td>ON</td> <td>ON</td> <td>Reverse running</td> </tr> </tbody> </table> </div> <p>2: 3-wire control 1; This mode defines Sin as enabling terminal, and the running command is generated by FWD, the direction is controlled by REV. During running, the Sin terminal should be closed, and terminal FWD generates a rising edge signal, then the inverter starts to run in the direction set by the state of terminal REV; the inverter should be stopped by disconnecting</p>	FWD	REV	Running command	OFF	OFF	Stop	ON	OFF	Forward running	OFF	ON	Reverse running	ON	ON	Hold	FWD	REV	Running command	OFF	OFF	Stop	ON	OFF	Forward running	OFF	ON	Stop	ON	ON	Reverse running	0	©
FWD	REV	Running command																																
OFF	OFF	Stop																																
ON	OFF	Forward running																																
OFF	ON	Reverse running																																
ON	ON	Hold																																
FWD	REV	Running command																																
OFF	OFF	Stop																																
ON	OFF	Forward running																																
OFF	ON	Stop																																
ON	ON	Reverse running																																

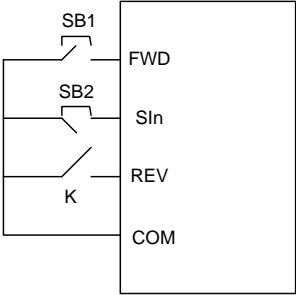
Function code	Name	Detailed parameter description	Default value	Modify																					
		<p>terminal Sin.</p>  <p>The direction control during running is shown below.</p> <table border="1" data-bbox="393 624 833 943"> <thead> <tr> <th>SIn</th> <th>REV</th> <th>Previous running direction</th> <th>Current running direction</th> </tr> </thead> <tbody> <tr> <td rowspan="2">ON</td> <td rowspan="2">OFF→ON</td> <td>Forward</td> <td>Reverse</td> </tr> <tr> <td>Reverse</td> <td>Forward</td> </tr> <tr> <td rowspan="2">ON</td> <td rowspan="2">ON→OFF</td> <td>Reverse</td> <td>Forward</td> </tr> <tr> <td>Forward</td> <td>Reverse</td> </tr> <tr> <td rowspan="2">ON→OFF F</td> <td>ON</td> <td colspan="2" rowspan="2">Decelerate to stop</td> </tr> <tr> <td>OFF</td> </tr> </tbody> </table> <p>SIn: 3-wire control/Sin, FWD: Forward running, REV: Reverse running                      3: 3-wire control 2; This mode defines Sin as enabling terminal. The running command is generated by FWD or REV, and they control the running direction. During running, the terminal Sin should be closed, and terminal FWD or REV generates a rising edge signal to control the running and direction of inverter; the inverter should be stopped by disconnecting terminal Sin.</p>	SIn	REV	Previous running direction	Current running direction	ON	OFF→ON	Forward	Reverse	Reverse	Forward	ON	ON→OFF	Reverse	Forward	Forward	Reverse	ON→OFF F	ON	Decelerate to stop		OFF		
SIn	REV	Previous running direction	Current running direction																						
ON	OFF→ON	Forward	Reverse																						
		Reverse	Forward																						
ON	ON→OFF	Reverse	Forward																						
		Forward	Reverse																						
ON→OFF F	ON	Decelerate to stop																							
	OFF																								

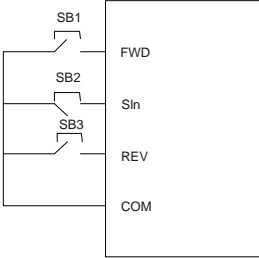
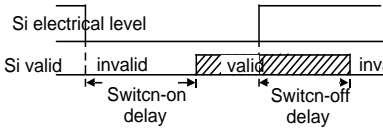
Function code	Name	Detailed parameter description	Default value	Modify																							
		 <table border="1" data-bbox="393 475 833 775"> <thead> <tr> <th>SIn</th> <th>FWD</th> <th>REV</th> <th>Running direction</th> </tr> </thead> <tbody> <tr> <td rowspan="2">ON</td> <td>OFF→ON</td> <td>ON</td> <td>Forward</td> </tr> <tr> <td></td> <td>OFF</td> <td>Forward</td> </tr> <tr> <td rowspan="2">ON</td> <td>ON</td> <td rowspan="2">OFF→ON</td> <td>Reverse</td> </tr> <tr> <td>OFF</td> <td>Reverse</td> </tr> <tr> <td rowspan="2">ON→OFF</td> <td></td> <td></td> <td rowspan="2">Decelerate to stop</td> </tr> <tr> <td></td> <td></td> </tr> </tbody> </table> <p>SIn: 3-wire control/SIn, FWD: Forward running, REV: Reverse running</p> <p><b>Note:</b> For dual-line running mode, when FWD/REV terminal is valid, if the inverter stops due to stop command given by other sources, it will not run again after the stop command disappears even if the control terminals FWD/REV are still valid. To make the inverter run again, users need to trigger FWD/REV again.</p>	SIn	FWD	REV	Running direction	ON	OFF→ON	ON	Forward		OFF	Forward	ON	ON	OFF→ON	Reverse	OFF	Reverse	ON→OFF			Decelerate to stop				
SIn	FWD	REV	Running direction																								
ON	OFF→ON	ON	Forward																								
		OFF	Forward																								
ON	ON	OFF→ON	Reverse																								
	OFF		Reverse																								
ON→OFF			Decelerate to stop																								
P05.12	S1 terminal switch-on delay	These function codes define corresponding delay of the programmable input terminals during level variation from switch-on to switch-off .	0.000s	○																							
P05.13	S1 terminal switch-off delay		0.000s	○																							
P05.14	S2 terminal switch-on delay			0.000s	○																						
P05.15	S2 terminal switch-off delay		Setting range: 0.000–50.000s	0.000s	○																						
P05.16	S3 terminal switch-on delay		<b>Note:</b> After a virtual terminal is enabled, the state of the terminal can be changed only in communication mode. The communication	0.000s	○																						
P05.17	S3 terminal switch-off delay			0.000s	○																						

S1 series standard inverter

Function code	Name	Detailed parameter description	Default value	Modify
P05.18	S4 terminal switch-on delay	address is 0x200A. Up to 2.2kW only there is 1 channel HDI	0.000s	○
P05.19	S4 terminal switch-off delay		0.000s	○
P05.20	HDI/HDIA terminal switch-on delay		0.000s	○
P05.21	HDI/HDIA terminal switch-off delay		0.000s	○
P05.22	HDIB terminal switch-on delay		0.000s	○
P05.23	HDIB terminal switch-off delay		0.000s	○
P05.24	Lower limit value of AI1		These function codes define the relation between analog input voltage and corresponding set value of analog input. When the analog input voltage exceeds the range of max./min. input, the max. input or min. input will be adopted during calculation. When analog input is current input, 0–20mA current corresponds to 0–10V voltage. In different applications, 100% of analog setting corresponds to different nominal values. Input filter time: Adjust the sensitivity of analog input, increase this value properly can enhance the anti-interference capacity of analog variables; however, it will also degrade the sensitivity of analog input. <b>Note:</b> AI1 supports 0 – 10V input and AI2 supports 0 – 10V or 0 – 20mA input, when AI2 selects 0 – 20mA input, the corresponding voltage of 20mA is 10V. AI3 can support the output of -10V – +10V (up to 2.2kW). AI1 can support 0-10V/0-20mA input, when AI1 selects 20mA input, the corresponding voltage of 20mA is 10V; AI2 supports -10V+10V input (from 4kW and higher).	0.00V
P05.25	Corresponding setting of lower limit of AI1	0.0%		○
P05.26	Upper limit value of AI1	10.00V		○
P05.27	Corresponding setting of upper limit of AI1	100.0%		○
P05.28	Input filter time of AI1	0.030s		○
P05.29	Lower limit value of AI2	-10.00V		○
P05.30	Corresponding setting of lower limit of AI2	-100.0%		○
P05.31	Intermediate value 1 of AI2	0.00V		○
P05.32	Corresponding setting of intermediate value 1 of AI2	0.0%		○
P05.33	Intermediate	0.00V		○

S1 series standard inverter

Function code	Name	Detailed parameter description	Default value	Modify
	value 2 of AI2	The default value depends on the model.		
P05.34	Corresponding setting of intermediate value 2 of AI2		0.0%	<input type="radio"/>
P05.35	Upper limit value of AI2		10.00V	<input type="radio"/>
P05.36	Corresponding setting of upper limit of AI2		100.0%	<input type="radio"/>
P05.37	Input filter time of AI2		0.030s	<input type="radio"/>
P05.38	Lower limit of AI3		-10.00V	<input type="radio"/>
P05.39	Corresponding setting of the lower limit of AI3		-100.0%	<input type="radio"/>
P05.40	Middle value of AI3		0.00V	<input type="radio"/>
P05.41	Corresponding middle setting of AI3		0.0%	<input type="radio"/>
P05.42	Upper limit of AI3		10.00V	<input type="radio"/>
P05.43	Corresponding setting of the upper limit of AI3		100.0%	<input type="radio"/>
P05.44	AI3 input filter time		0.100s	<input type="radio"/>
P05.45	Lower limit frequency of HDI/HDIA		0.000 KHz – P05.41	0.000 KHz
P05.46	Corresponding setting of lower limit frequency of HDI/HDIA	-100.0%–100.0%	0.0%	<input type="radio"/>
P05.47	Upper limit frequency of HDI/HDIA	P05.39 –50.000KHz	50.000 KHz	<input type="radio"/>
P05.48	Corresponding setting of upper limit frequency of	-100.0%–100.0%	100.0%	<input type="radio"/>

S1 series standard inverter

Function code	Name	Detailed parameter description	Default value	Modify
	HDI/HDIA			
P05.49	HDI/HDIA frequency input filter time	0.000s–10.000s	0.030s	○
P05.50	Lower limit frequency of HDIB	0.000 KHz – P05.47	0.000 KHz	○
P05.51	Corresponding setting of lower limit frequency of HDIB	-100.0%–100.0%	0.0%	○
P05.52	Upper limit frequency of HDIB	P05.45 –50.000KHz	50.000 KHz	○
P05.53	Corresponding setting of upper limit frequency of HDIB	-100.0%–100.0%	100.0%	○
P05.54	HDIB frequency input filter time	0.000s–10.000s	0.030s	○
P05.55	AI1 input signal type	0: Voltage type 1: Current type <b>Note:</b> You can set the AI1 input signal type through the corresponding function code (up to 2.2kW the AI1 is set by protentiometer).	0	◎
<b>P06 group Output terminals</b>				
P06.00	HDO output type	0: Open collector high-speed pulse output: Max. frequency of the pulse is 50.00kHz. For details about the related functions, see P06.27–P06.31. 1: Open collector output: For details about the related functions, see P06.02. <b>Note:</b> up to 2.2kW there is no HDO terminal.	0	◎
P06.01	Y output selection	0: Invalid	0	○
P06.02	HDO output selection	1: In running 2: In forward running	0	○
P06.03	Relay RO1 output selection	3: In reverse running 4: In jogging	1	○
P06.04	Relay RO2 output	5: Inverter fault	5	○

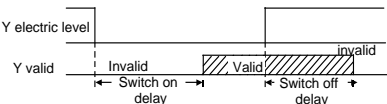
Function code	Name	Detailed parameter description	Default value	Modify								
	selection	6: Frequency level detection FDT1 7: Frequency level detection FDT2 8: Frequency reached 9: Running in zero speed 10: Reach upper limit frequency 11: Reach lower limit frequency 12: Ready to run 13: In pre-exciting 14: Overload pre-alarm 15: Underload pre-alarm 16 – 17: Reserved 18: Reach set counting value 19: Reach designated counting value 20: External fault is valid 21: Reserved 22: Reach running time 23: Virtual terminal output of Modbus communication 24 - 25: Reserved 26: DC bus voltage established 27: STO action										
P06.05	Output terminal polarity selection	<p>This function code is used to set the polarity of output terminals.</p> <p>When the bit is set to 0, input terminal polarity is positive;</p> <p>When the bit is set to 1 input terminal polarity is negative.</p> <table border="1" style="margin-left: auto; margin-right: auto;"> <tr> <td style="text-align: center;">BIT3</td> <td style="text-align: center;">BIT2</td> <td style="text-align: center;">BIT1</td> <td style="text-align: center;">BIT0</td> </tr> <tr> <td style="text-align: center;">RO2</td> <td style="text-align: center;">RO1</td> <td style="text-align: center;">HDO</td> <td style="text-align: center;">Y</td> </tr> </table> <p>Setting range: 0x0–0xF</p>	BIT3	BIT2	BIT1	BIT0	RO2	RO1	HDO	Y	00	○
BIT3	BIT2	BIT1	BIT0									
RO2	RO1	HDO	Y									
P06.06	Y switch-on delay	<p>This function code defines the corresponding delay of the level variation from switch-on to switch-off.</p> 	0.000s	○								
P06.07	Y switch-off delay		0.000s	○								
P06.08	HDO switch-on delay		0.000s	○								
P06.09	HDO switch-off delay		0.000s	○								
P06.10	Relay RO1 switch-on delay		0.000s	○								
		Setting range: 0.000–50.000s										



S1 series standard inverter

Function code	Name	Detailed parameter description	Default value	Modify
P06.11	Relay RO1 switch-off delay	<b>Note: P06.08 and P06.09 are valid only when P06.00=1.</b>	0.000s	<input type="radio"/>
P06.12	Relay RO2 switch-on delay		0.000s	<input type="radio"/>
P06.13	Relay RO2 switch-off delay		0.000s	<input type="radio"/>
P06.14	AO1 output selection	0: Running frequency 1: Set frequency	0	<input type="radio"/>
P06.15	Reserved variables	2: Ramps reference frequency 3: Running speed	0	<input type="radio"/>
P06.16	HDO high-speed pulse output	4: Output current (relative to inverter) 5: Output current (relative to motor) 6: Output voltage 7: Output power 8: Set torque value 9: Output torque 10: AI1 input value 11: AI2input value 12: AI3 input value 13: Input value of high-speed pulse HDI/HDIA 14: Set value 1 of Modbus communication 15: Set value 2 of Modbus communication 16 - 21: Reserved 22: Torque current (bipolar, 100% corresponds to 10V) 23: Ramps reference frequency (bipolar)	0	<input type="radio"/>
P06.17	Lower limit of AO1 output	-300.0%~P06.19	0.0%	<input type="radio"/>
P06.18	Corresponding AO1 output of lower limit	0.00V~10.00V	0.00V	<input type="radio"/>
P06.19	Upper limit of AO1 output	P06.17~300.0%	100.0%	<input type="radio"/>
P06.20	Corresponding AO1 output of upper limit	0.00V~10.00V	10.00V	<input type="radio"/>
P06.21	AO1 output filter time	0.000s~10.000s	0.000s	<input type="radio"/>

S1 series standard inverter

Function code	Name	Detailed parameter description	Default value	Modify
P06.22–P06.26	Reserved variables	0–65535	0	●
P06.27	Lower limit of HDO output	-100.0%–P06.29	0.00%	○
P06.28	Corresponding HDO output of lower limit	0.00–50.00kHz	0.00kHz	○
P06.29	Upper limit of HDO output	P06.27–100.0%	100.0%	○
P06.30	Corresponding HDO output of upper limit	0.00–50.00kHz	50.00 kHz	○
P06.31	HDO output filter time	0.000s–10.000s	0.000s	○
<b>P07 group Human-Machine Interface</b>				
P07.00	User password	<p>0–65535</p> <p>Set it to any non-zero value to enable password protection.</p> <p>00000: Clear previous user password and disable password protection.</p> <p>After user password becomes valid, if wrong password is inputted, users will be denied entry. It is necessary to keep the user password in mind.</p> <p>Password protection will be effective one minute after exiting function code edit state, and it will display "0.0.0.0.0" if users press <b>PRG/ESC</b> key to enter function code edit state again, users need to input the correct password.</p> <p><b>Note:</b> Restoring to default values will clear user password, use this function with caution.</p>	0	○
P07.01	Parameter copy	<p>0: No operation</p> <p>1: Upload the local function parameter to the keypad</p> <p>2: Download the keypad function parameter to local address (including the motor parameters)</p> <p>3: Download the keypad function parameter to local address (excluding the motor parameter of P02 and P12 group)</p> <p>4: Download the keypad function parameters to local address (only for the motor parameter of P02 and P12 group)</p>	0	◎

Function code	Name	Detailed parameter description	Default value	Modify
		<b>Note:</b> After finish 1 – 4, the parameter will restore to 0 and the uploading and downloading does not include P29.		
P07.02	Function of keys	Range: 0x00–0x27 Ones: Function selection of <b>QUICK/JOG</b> key 0: No function 1: Jogging 2: Reserved 3: Forward/reverse rotation switch-over 4: Clear <b>UP/DOWN</b> setting 5: Coast to stop 6: Switch over the running command reference mode in sequence 7: Reserved Tens: Reserved	0x01	◎
P07.03	Running command channel switch-over sequence of <b>QUICK</b> key	When P07.02=6, set the switch-over sequence of running command channel. 0: keypad control→terminal control→communication control 1: keypad control←→terminal control 2: keypad control←→communication control 3: terminal control←→communication control	0	○
P07.04	Stop function selection of <b>STOP/RST</b> key	Validness selection of stop function of <b>STOP/RST</b> . For fault reset, <b>STOP/RST</b> is valid under any situation. 0: valid only for panel control only 1: valid for both panel and terminal control 2: valid for both panel and communication control 3: valid for all control modes	0	○
P07.05	Displayed parameters 1 of running state	0x0000 – 0xFFFF BIT0: running frequency (Hz on) BIT1: set frequency (Hz flickering) BIT2: bus voltage (Hz on) BIT3: output voltage (V on) BIT4: output current (A on) BIT5: running rotation speed (rpm on) BIT6: output power (% on) BIT7: output torque (% on) BIT8: PID reference (% flickering) BIT9: PID feedback value (% on) BIT10: input terminals state BIT11: output terminals state	0x03FF	○

Function code	Name	Detailed parameter description	Default value	Modify
		BIT12: torque set value (% on) BIT13: pulse counter value BIT14: reserved BIT15: current step of multi-step speed		
P07.06	Displayed parameters 2 of running state	0x0000 – 0xFFFF BIT0: analog AI1 value (V on) BIT1: analog AI2 value (V on) BIT2: analog AI3 value (V on) BIT3: high speed pulse HDI frequency BIT4: motor overload percentage (% on) BIT5: the inverter overload percentage (% on) BIT6: ramp frequency given value (Hz on) BIT7: linear speed BIT8: AC inlet current (A on) BIT9 – 15: reserved	0x0000	
P07.07	The parameter selection of the stop state	0x0000 – 0xFFFF BIT0: set frequency (Hz on, frequency flickering slowly) BIT1: bus voltage (V on) BIT2: input terminals state BIT3: output terminals state BIT4: PID reference (% flickering) BIT5: PID feedback value (% flickering) BIT6: torque reference (% flickering) BIT7: analog AI1 value (V on) BIT8: analog AI2 value (V on) BIT9: analog AI3 value (V on) BIT10: high speed pulse HDI frequency BIT11: current step of multi-step speed BIT12: pulse counters BIT13 – BIT15: reserved	0x00FF	○
P07.08	Frequency display coefficient	0.01–10.00 Display frequency=running frequency× P07.08	1.00	○
P07.09	Speed display coefficient	0.1–999.9% Mechanical speed=120×display running frequency×P07.09/number of motor pole pairs	100.0%	○
P07.10	Linear speed display coefficient	0.1–999.9% Linear speed=mechanical speed×P07.10	1.0%	○
P07.11	Temperature of rectifier bridge module	-20.0–120.0°C	/	●
P07.12	Temperature of inverter module	-20.0–120.0°C	/	●
P07.13	Software version of control board	1.00–655.35	/	●
P07.14	Accumulated	0–65535h	/	●

S1 series standard inverter

Function code	Name	Detailed parameter description	Default value	Modify
	running time			
P07.15	High bit of inverter power consumption	Display the power consumption of the inverter. power consumption=P07.15×1000+P07.16	/	●
P07.16	Low bit of inverter power consumption	Setting range of P07.15: 0–65535 kWh (×1000) Setting range of P07.16: 0.0–999.9 kWh	/	●
P07.17	Dual ratings	0: ND rating 1: LD rating	/	/
P07.18	Rated power of inverter	0.4–3000.0kW	/	●
P07.19	Rated voltage of inverter	50–1200V	/	●
P07.20	Rated current of inverter	0.1–6000.0A	/	●
P07.21	Factory barcode 1	0x0000–0xFFFF	/	●
P07.22	Factory barcode 2	0x0000–0xFFFF	/	●
P07.23	Factory barcode 3	0x0000–0xFFFF	/	●
P07.24	Factory barcode 4	0x0000–0xFFFF	/	●
P07.25	Factory barcode 5	0x0000–0xFFFF	/	●
P07.26	Factory barcode 6	0x0000–0xFFFF	/	●
P07.27	Type of present fault	0: No fault 1: Inverter unit U phase protection (OUT1)	/	●
P07.28	Type of the last fault	2: Inverter unit V phase protection (OUT2) 3: Inverter unit W phase protection (OUT3)	/	●
P07.29	Type of the last but one fault	4: Overcurrent during acceleration (OC1) 5: Overcurrent during deceleration (OC2)	/	●
P07.30	Type of the last but two fault	6: Overcurrent during constant speed (OC3) 7: Overvoltage during acceleration (OV1)	/	●
P07.31	Type of the last but three fault	8: Overvoltage during deceleration (OV2) 9: Overvoltage during constant speed (OV3)	/	●
P07.32	Type of the last but four fault	10: Bus undervoltage fault (UV) 11: Motor overload (OL1) 12: Inverter overload (OL2) 13: Phase loss on input side (SPI) 14: Phase loss on output side (SPO) 15: Rectifier module overheat (OH1) 16: Inverter module overheat (OH2)	/	●

S1 series standard inverter

Function code	Name	Detailed parameter description	Default value	Modify
		17: External fault (EF) 18: 485 communication fault (CE) 19: Current detection fault (ItE) 20: Motor autotuning fault (tE) 21: EEPROM operation fault (EEP) 22: PID feedback offline fault (PIDE) 23: Brake unit fault (bCE) 24: Running time reached (END) 25: Electronic overload (OL3) 26: Keypad communication error (PCE) 27: Parameter upload error (UPE) 28: Parameter download error (DNE) 29 - 31: Reserved 32: To-ground short-circuit fault 1 (ETH1) 33: To-ground short-circuit fault 2 (ETH2) 34: Speed deviation fault (dEu) 35: Mal-adjustment fault (STo) 36: Underload fault (LL) 37: Safe torque off (STO) 38: Channel H1 safety circuit exception (STL1) 39: Channel H2 safety circuit exception (STL2) 40: Channel H1 and H2 exception (STL3) 41: Safety code FLASH CRC fault (CrCE)		
P07.33	Running frequency of present fault		0.00Hz	●
P07.34	Ramps reference frequency of present fault		0.00Hz	●
P07.35	Output voltage of present fault		0V	●
P07.36	Output current of present fault		0.0A	●
P07.37	Bus voltage of present fault		0.0V	●
P07.38	Max. temperature of present fault		0.0°C	●
P07.39	Input terminal state of present fault		0	●
P07.40	Output terminal state of present fault		0	●
P07.41	Running frequency of the last fault		0.00Hz	●
P07.42	Ramps reference frequency of the last fault		0.00Hz	●
P07.43	Output voltage of the last fault		0V	●
P07.44	Output current of the last fault		0.0A	●
P07.45	Bus voltage of the last fault		0.0V	●
P07.46	Max. temperature of the last fault		0.0°C	●
P07.47	Input terminal state of the last fault		0	●

S1 series standard inverter

Function code	Name	Detailed parameter description	Default value	Modify
P07.48	Output terminal state of the last fault		0	●
P07.49	Running frequency of the last but one fault		0.00Hz	●
P07.50	Ramps reference frequency of the last but one fault		0.00Hz	●
P07.51	Output voltage of the last but one fault		0V	●
P07.52	Output current of the last but one fault		0.0A	●
P07.53	Bus voltage of the last but one fault		0.0V	●
P07.54	Max. temperature of the last but one fault		0.0°C	●
P07.55	Input terminal state of the last but one fault		0	●
P07.56	Output terminal state of the last but one fault		0	●
<b>P08 group Enhanced functions</b>				
P08.00	Acceleration time 2	See P00.11 and P00.12 for detailed definitions. S1 series inverter defines four groups of acceleration/deceleration time, which can be selected by multi-function digital input terminal (P05 group). The acceleration/deceleration time of the inverter is the first group by default. Setting range: 0.0–3600.0s	Depend on model	○
P08.01	Deceleration time 2		Depend on model	○
P08.02	Acceleration time 3		Depend on model	○
P08.03	Deceleration time 3		Depend on model	○
P08.04	Acceleration time 4		Depend on model	○
P08.05	Deceleration time 4		Depend on model	○
P08.06	Running frequency of jogging	This function code is used to define the reference frequency of the inverter during jogging. Setting range: 0.00Hz–P00.03 (Max. output frequency)	5.00Hz	○
P08.07	Acceleration time of jogging	Jogging acceleration time is the time needed for the inverter to accelerate from 0Hz to Max. output frequency (P00.03).	Depend on model	○
P08.08	Deceleration time of jogging	Jogging deceleration time is the time needed from decelerating from Max. output frequency (P00.03) to 0Hz.		○

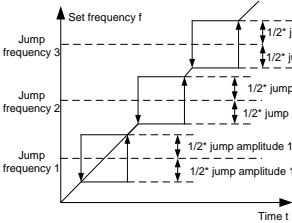
Function code	Name	Detailed parameter description	Default value	Modify
		Setting range: 0.0–3600.0s		
P08.09	Jump frequency 1	When the set frequency is within the range of jump frequency, the inverter will run at the boundary of jump frequency.  The inverter can avoid mechanical resonance point by setting the jump frequency, and three jump frequency points can be set. If the jump frequency points are set to 0, this function will be invalid.	0.00Hz	○
P08.10	Jump frequency amplitude 1		0.00Hz	○
P08.11	Jump frequency 2		0.00Hz	○
P08.12	Jump frequency amplitude 2		0.00Hz	○
P08.13	Jump frequency 3		0.00Hz	○
P08.14	Jump frequency amplitude 3	 <p>Setting range: 0.00Hz–P00.03 (Max. output frequency)</p>	0.00Hz	○
P08.15	Amplitude of wobbling frequency	0.0–100.0% (relative to set frequency)	0.0%	○
P08.16	Amplitude of jump frequency	0.0–50.0% (relative to amplitude of wobbling frequency)	0.0%	○
P08.17	Rise time of wobbling frequency	0.1–3600.0s	5.0s	○
P08.18	Descend time of wobbling frequency	0.1–3600.0s	5.0s	○
P08.19	Number of decimal points of linear speed/frequency	Ones: decimals of linear speed display 0: no decimals 1: one decimal 2: two decimals 3: three decimals Tens: decimals of frequency display 0: two decimals 1: one decimal	0x00	○
P08.20	Analog calibration	0: Disabled	0	⊙



S1 series standard inverter

Function code	Name	Detailed parameter description	Default value	Modify
	function setting	1: Enabled		
P08.21	Delay for entering the sleep state	0.0-3600.0s It indicates the delay for entering the sleep state, and is valid only when P0.19 is set to 2.	2.0s	○
P08.25	Set count value	P08.26-65535	0	○
P08.26	Designated count value	0-P08.25	0	○
P08.27	Set running time	0-65535min	0min	○
P08.28	Automatic fault reset times	Automatic fault reset times: When the inverter selects automatic fault reset, it is used to set the times of automatic reset, if the continuous reset times exceeds the value set by P08.29, the inverter will report fault and stop to wait for repair. Interval of automatic fault reset: select the interval time from when fault occurred to automatic fault reset actions.	0	○
P08.29	Automatic fault reset time interval	After inverter starts, if no fault occurred during 60s, the fault reset times will be zeroed out. Setting range of P08.28: 0-10 Setting range of P08.29: 0.1-3600.0s	1.0s	○
P08.30	Reduction ratio of droop control	This function code sets the variation rate of the inverter output frequency based on the load; it is mainly used in balancing the power when multiple motors drive the same load. Setting range: 0.00-50.00Hz	0.00Hz	○
P08.31	Switch-over between motor 1 and motor 2	0x00-0x14 Ones: Switch-over channel 0: Switch over by terminal 1: Switch over by Modbus communication Tens: Motor switch over during running 0: Disable switch over during running 1: Enable switch over during running	0x00	◎
P08.32	FDT1 level detection value	When the output frequency exceeds the corresponding frequency of FDT level,	50.00Hz	○
P08.33	FDT1 lag detection value	multi-function digital output terminal outputs "frequency level detection FDT" signal, this signal will be valid until the output frequency lowers to	5.0%	○
P08.34	FDT2 level detection value	below the corresponding frequency (FDT	50.00Hz	○

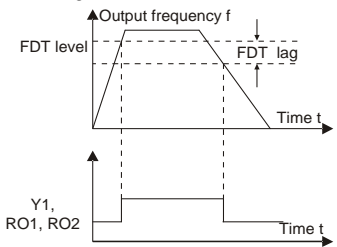
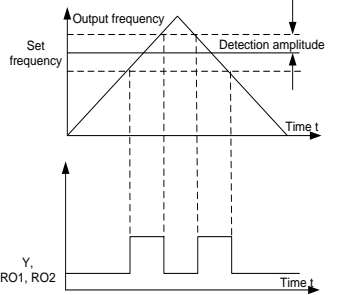
Function code	Name	Detailed parameter description	Default value	Modify
P08.35	FDT2 lag detection value	<p>level-FDT lag detection value), the waveform is shown in the figure below.</p>  <p>Setting range of P08.32: 0.00Hz~P00.03 (Max. output frequency)                      Setting range of P08.33: 0.0~100.0% (FDT1 level)                      Setting range of P08.34: 0.00Hz~P00.03 (Max. output frequency)                      Setting range of P08.35: 0.0~100.0% (FDT2 level)</p>	5.0%	○
P08.36	Detection value for frequency arrival	<p>When the output frequency is within the positive /negative detection range of the set frequency, the multi-function digital output terminal outputs "frequency arrival" signal as shown below.</p>  <p>Setting range: 0.00Hz~P00.03 (Max. output frequency)</p>	0.00Hz	○
P08.37	Enable/disable energy-consumption brake	<p>0: Disable energy-consumption                      1: Enable energy-consumption</p>	1	○
P08.38	Energy-consumption brake threshold	<p>Set the starting bus voltage of energy-consumption brake, adjust this value properly can brake the load effectively. The</p>	230V voltage: 380.0V;	○

S1 series standard inverter

Function code	Name	Detailed parameter description	Default value	Modify
	voltage	default value will change with the change of voltage class. Setting range: 200.0–2000.0V	400V voltage: 700.0V;	
P08.39	Running mode of cooling fan	0: Common running mode 1: The fan keeps running after power up	0	○
P08.40	PWM selection	0x0000–0x2121 Ones: PWM mode 0: 3PH modulation and 2PH modulation 1: 3PH modulation Tens: PWM low-speed carrier limit 0: Limit low-speed carrier to 2K 1: Limit low-speed carrier to 4K 2: No limit on low-speed carrier	0x01	◎
P08.41	Overmodulation selection	0x00–0x11 Ones 0: Overmodulation is invalid 1: Overmodulation is valid Tens 0: Mild overmodulation 1: Deepened overmodulation	01	◎
P08.42	Keypad digital control setting	0x0000 – 0x1223 LED ones: frequency enable selection 0: Both $\wedge/\vee$ keys and potentiometer adjustments are valid 1: Only $\wedge/\vee$ keys adjustment is valid 2: Only potentiometer adjustments is valid 3: Neither $\wedge/\vee$ keys nor potentiometer adjustments are valid LED tens: frequency control selection 0: Valid only when $P00.06=0$ or $P00.07=0$ 1: Valid for all frequency setting modes 2: Invalid for multi-step speed when multi-step speed has the priority LED hundreds: action selection during stopping 0: Setting is valid 1: Valid during running, cleared after stopping 2: Valid during running, cleared after receiving the stop command LED thousands: $\wedge/\vee$ keys and potentiometer integral function 0: The Integral function is valid 1: The Integral function is invalid	0x000	○
P08.43	Reserved variables		/	/
P08.44	UP/DOWN	0x000–0x221	0x000	○

S1 series standard inverter

Function code	Name	Detailed parameter description	Default value	Modify
	terminal control setup	Ones: Frequency control selection 0: UP/DOWN terminal setup is valid 1: UP/DOWN terminal setup is invalid Tens: Frequency control selection 0: Valid only when P00.06=0 or P00.07=0 1: All frequency modes are valid 2: Invalid for multi-step speed when multi-step speed takes priority Hundreds: Action selection during stop 0: Valid 1: Valid during running, clear after stop 2: Valid during running, clear after receiving stop command		
P08.45	UP terminal frequency incremental integral rate	0.01–50.00Hz/s	0.50Hz/s	<input type="radio"/>
P08.46	DOWN terminal frequency decremental change rate	0.01–50.00Hz/s	0.50Hz/s	<input type="radio"/>
P08.47	Action selection for frequency setup during power down	0x000–0x111 Ones: Action selection for frequency setup (by keypad digits) during power down 0: Save during power down 1: Zero out during power down Tens: Action selection for frequency setup (by Modbus) during power down 0: Save during power down 1: Zero out during power down Hundreds: Action selection for frequency setup (by other communication) during power down 0: Save during power down 1: Zero out during power down	0x000	<input type="radio"/>
P08.48	High bit of initial value of power consumption	Set the initial value of power consumption. Initial value of power consumption=P08.48×1000+ P08.49	0°	<input type="radio"/>
P08.49	Low bit of initial value of power	Setting range of P08.48: 0–59999 kWh (k) Setting range of P08.49: 0.0–999.9 kWh	0.0°	<input type="radio"/>

S1 series standard inverter

Function code	Name	Detailed parameter description	Default value	Modify
	consumption			
P08.50	Flux braking	<p>This function code is used to enable flux braking function.</p> <p>0: Invalid</p> <p>100–150: The larger the coefficient, the stronger the brake intensity</p> <p>The inverter enables motor to decelerate quickly by increasing the motor flux which converts energy generated during braking into thermal energy.</p> <p>The inverter monitors motor state continuously even during flux braking, thus flux braking can be applied in motor stop or used to change motor speed. The flux braking also carries the following advantages.</p> <p>1) Brake immediately after sending stop command, removing the need to wait for flux to attenuate.</p> <p>2) Better cooling effect. During flux braking, the stator current of the motor increases, while the rotor current does not change, while the cooling effect of stator is much more effective than that of the rotor.</p>	0	○
P08.51	Current regulation coefficient on input side	<p>This function code is used to adjust the current display value on the AC input side.</p> <p>0.00–1.00</p>	0.56	○
P08.52	STO lock	<p>0: STO alarm lock</p> <p>Alarm-lock means STO alarm must be reset after state restoration when STO occurs.</p> <p>1: STO alarm unlock</p> <p>Alarm-unlock means when STO occurs, after state restoration, STO alarm will disappear automatically.</p>	0	○
<b>P09 group PID control</b>				
P09.00	PID reference source	<p>When frequency command (P00.06, P00.07) is set to 7, or channel of voltage setup (P04.27) is set to 6, the inverter running mode is process PID control.</p>	0	○

S1 series standard inverter

Function code	Name	Detailed parameter description	Default value	Modify
		<p>This parameter determines the target reference channel of process PID.</p> <p>0: Keypad (P09.01)            1: AI1            2: AI2            3: AI3 (up to 2.2kW)            4: High-speed pulse HDI/HDIA            5: Multi-step            6: Modbus communication            7 - 12: Reserved</p> <p>The set target value of process PID is relative value, the set 100% corresponds to 100% of the feedback signal of controlled system.</p> <p>The system operates based on the relative value (0–100.0%)</p>		
P09.01	Pre-set PID reference of keypad	<p>Users need to set this parameter when P09.00 is set to 0, the reference value of this parameter is the feedback variable of the system.</p> <p>Setting range: -100.0%–100.0%</p>	0.0%	<input type="radio"/>
P09.02	PID feedback source	<p>This parameter is used to select PID feedback channel.</p> <p>0: AI1            1: AI2            2: AI3 (up to 2.2kW)            3: High-speed pulse HDI/HDIA            4: Modbus communication            5 - 10: Reserved</p> <p><b>Note:</b> The reference channel and feedback channel cannot overlap; otherwise, PID cannot be controlled effectively.</p>	0	<input type="radio"/>
P09.03	PID output characteristics	<p>0: PID output is positive characteristic: namely, the feedback signal is larger than the PID reference, which requires the inverter output frequency to decrease for PID to reach balance, eg, tension PID control of winding</p> <p>1: PID output is negative characteristics: namely the feedback signal is less than PID reference, which requires inverter output frequency to increase for PID to reach balance, eg, tension PID</p>	0	<input type="radio"/>

Function code	Name	Detailed parameter description	Default value	Modify
		control of unwinding.		
P09.04	Proportional gain (Kp)	<p>This function code is suitable for proportional gain P of PID input.</p> <p>It determines the regulation intensity of the whole PID regulator, the larger the value of P, the stronger the regulation intensity. If this parameter is 100, it means when the deviation between PID feedback and reference is 100%, the regulation amplitude of PID regulator (ignoring integral and differential effect) on output frequency command is the max. frequency (ignoring integral and differential actions).</p> <p>Setting range: 0.00–100.00</p>	1.80	<input type="radio"/>
P09.05	Integral time (Ti)	<p>It determines the speed of integral regulation made on the deviation between PID feedback and reference by PID regulator. When the deviation between PID feedback and reference is 100%, the regulation of integral regulator (ignoring integral and differential actions), after undergoing continuous regulation during this time period, can reach Max. output frequency (P00.03)</p> <p>The shorter the integral time, the stronger the regulation intensity.</p> <p>Setting range: 0.00–10.00s</p>	0.90s	<input type="radio"/>
P09.06	Derivative time (Td)	<p>It determines the intensity of the regulation made on the change rate of deviation between PID feedback and reference by PID regulator. If feedback changes by 100% during this period, the regulation of differential regulator (ignoring integral and differential actions) is Max. output frequency (P00.03)</p> <p>The longer the derivative time, the stronger the regulation intensity.</p> <p>Setting range: 0.00–10.00s</p>	0.00s	<input type="radio"/>
P09.07	Sampling cycle (T)	<p>It means the sampling cycle of feedback. The regulator operates once during each sampling cycle. The larger the sampling cycle, the slower the response.</p> <p>Setting range: 0.001–10.000s</p>	0.001s	<input type="radio"/>

Function code	Name	Detailed parameter description	Default value	Modify
P09.08	Limit of PID control deviation	<p>It is the max. allowable deviation of PID system output value relative to closed-loop reference value. Within this limit, PID regulator stops regulation. Set this function code properly to regulate the precision and stability of PID system. Setting range: 0.0–100.0%</p>	0.0%	○
P09.09	Upper limit value of PID output	These two function codes are used to set the upper/lower limit value of PID regulator.	100.0%	○
P09.10	Lower limit value of PID output	100.0% corresponds to Max. output frequency (P00.03) or max. voltage (P04.31) Setting range of P09.09: P09.10–100.0% Setting range of P09.10: -100.0%–P09.09	0.0%	○
P09.11	Feedback offline detection value	Set PID feedback offline detection value, when the detection value is no more than the feedback offline detection value, and the duration exceeds the value set in P09.12, the inverter will report "PID feedback offline fault", and keypad displays PIDE.	0.0%	○
P09.12	Feedback offline detection time	<p>Setting range of P09.11: 0.0–100.0% Setting range of P09.12: 0.0–3600.0s</p>	1.0s	○
P09.13	PID control selection	0x0000–0x1111 Ones:	0x0001	○



Function code	Name	Detailed parameter description	Default value	Modify
		0: Continue integral control after the frequency reaches upper/lower limit 1: Stop integral control after the frequency reaches upper/lower limit Tens: 0: The same with the main reference direction 1: Contrary to the main reference direction Hundreds: 0: Limit based on the max. frequency 1: Limit based on A frequency Thousands: 0: A+B frequency, acceleration /deceleration of main reference A frequency source buffering is invalid 1: A+B frequency, acceleration/ deceleration of main reference A frequency source buffering is valid, acceleration and deceleration are determined by P08.04 (acceleration time 4).		
P09.14	Low-frequency proportional gain (Kp)	0.00–100.00 Low-frequency switching point: 5.00Hz, high-frequency switching point: 10.00Hz (P09.04 corresponds to high-frequency parameter), and the middle is the linear interpolation between these two points	1.00	○
P09.15	Acceleration/ deceleration time of PID command	0.0–1000.0s	0.0s	○
P09.16	Filter time of PID output	0.000–10.000s	0.000s	○
<b>P10 group Multi-step speed control</b>				
P10.02	Multi-step speed 0	Setting range of the frequency in 0 <sup>th</sup> –15 <sup>th</sup> sections are -100.0–100.0%, 100% corresponds to Max. output frequency P00.03. Setting range of the running time in 0 <sup>th</sup> –15 <sup>th</sup> sections are 0.0–6553.5s (min), the time unit is determined by P10.37.	0.0%	○
P10.03	Running time of 0 <sup>th</sup> step		0.0s(min)	○
P10.04	Multi-step speed 1		0.0%	○
P10.05	Running time of 1 <sup>st</sup> step		0.0s(min)	○
P10.06	Multi-step speed 2		0.0%	○
P10.07	Running time of		0.0s(min)	○

Function code	Name	Detailed parameter description	Default value	Modify
	2 <sup>nd</sup> step			
P10.08	Multi-step speed 3	<p>When selecting multi-step speed running, the multi-step speed is within the range of -fmax~fmax, and it can be set continuously. The start/stop of multi-step stop is also determined by P00.01.</p> <p>S1 series inverter can set 16-step speed, which are set by combined codes of multi-step terminals 1~4 (set by S terminal, correspond to function code P05.01~P05.06) and correspond to multi-step speed 0 to multi-step speed 15.</p> <p>When terminal 1, terminal 2, terminal 3 and terminal 4 are OFF, the frequency input mode is set by P00.06 or P00.07. When terminal 1, terminal 2, terminal 3 and terminal 4 are not all OFF, the frequency set by multi-step speed will prevail, and the priority of multi-step setting is higher than that of the keypad, analog, high-speed pulse, PID, and communication settings.</p> <p>The relation between terminal 1, terminal 2, terminal 3 and terminal 4 are shown in the table</p>	0.0%	<input type="radio"/>
P10.09	Running time of 3 <sup>rd</sup> step		0.0s(min)	<input type="radio"/>
P10.10	Multi-step speed 4		0.0%	<input type="radio"/>
P10.11	Running time of 4 <sup>th</sup> step		0.0s(min)	<input type="radio"/>
P10.12	Multi-step speed 5		0.0%	<input type="radio"/>
P10.13	Running time of 5 <sup>th</sup> step		0.0s(min)	<input type="radio"/>
P10.14	Multi-step speed 6		0.0%	<input type="radio"/>
P10.15	Running time of 6 <sup>th</sup> step		0.0s(min)	<input type="radio"/>
P10.16	Multi-step speed 7		0.0%	<input type="radio"/>
P10.17	Running time of 7 <sup>th</sup> step		0.0s(min)	<input type="radio"/>
P10.18	Multi-step speed 8		0.0%	<input type="radio"/>
P10.19	Running time of 8 <sup>th</sup> step		0.0s(min)	<input type="radio"/>
P10.20	Multi-step speed 9		0.0%	<input type="radio"/>
P10.21	Running time of 9 <sup>th</sup> step		0.0s(min)	<input type="radio"/>
P10.22	Multi-step speed 10		0.0%	<input type="radio"/>
P10.23	Running time of 10 <sup>th</sup> step		0.0s(min)	<input type="radio"/>
P10.24	Multi-step speed 11	0.0%	<input type="radio"/>	
P10.25	Running time of 11 <sup>th</sup> step	0.0s(min)	<input type="radio"/>	
P10.26	Multi-step speed 12	0.0%	<input type="radio"/>	
P10.27	Running time of 12 <sup>th</sup> step	0.0s(min)	<input type="radio"/>	
P10.28	Multi-step speed 13	0.0%	<input type="radio"/>	

Function code	Name	Detailed parameter description	Default value	Modify
P10.29	Running time of 13 <sup>th</sup> step	below. Terminal 1 OFF ON OFF ON OFF ON OFF ON	0.0s(min)	<input type="radio"/>
P10.30	Multi-step speed 14	Terminal 2 OFF OFF ON ON OFF OFF ON ON Terminal 3 OFF OFF OFF OFF ON ON ON ON	0.0%	<input type="radio"/>
P10.31	Running time of 14 <sup>th</sup> step	Terminal 4 OFF OFF OFF OFF OFF OFF OFF OFF Step 0 1 2 3 4 5 6 7	0.0s(min)	<input type="radio"/>
P10.32	Multi-step speed 15	Terminal 1 OFF ON OFF ON OFF ON OFF ON Terminal 2 OFF OFF ON ON OFF OFF ON ON	0.0%	<input type="radio"/>
P10.33	Running time of 15 <sup>th</sup> step	Terminal 3 OFF OFF OFF OFF ON ON ON ON Terminal 4 ON ON ON ON ON ON ON ON Step 8 9 10 11 12 13 14 15	0.0s(min)	<input type="radio"/>
P10.37	Multi-step time unit	0: s; the running time of each step is counted in seconds; 1: min; the running time of each step is counted in minutes;	0	<input checked="" type="radio"/>
<b>P11 group Protection parameters</b>				
P11.00	Phase-loss protection	0x000–0x111 Ones: 0: Disable software input phase loss protection 1: Enable software input phase loss protection Tens: 0: Disable output phase loss protection 1: Enable output phase loss protection Hundreds: 0: Disable hardware input phase loss protection 1: Enable hardware input phase loss protection	0x110	<input type="radio"/>
P11.01	Frequency-drop at transient power down	0: Disable 1: Enable	0	<input type="radio"/>
P11.02	Frequency-drop ratio at sudden power dip	Setting range: 0.00Hz/s – P00.03 (the max. frequency) After the power loss of the grid, the bus voltage drops to the sudden frequency-decreasing point, the inverter begin to decrease the running frequency at P11.02, to make the inverter generate power again. The returning power can maintain the bus voltage to ensure a rated running of the inverter until the recovery of power. <b>Note:</b> 1. Adjust the parameter properly to avoid the stopping caused by inverter protection during the switching of the grid.	10.00 Hz/s	<input type="radio"/>

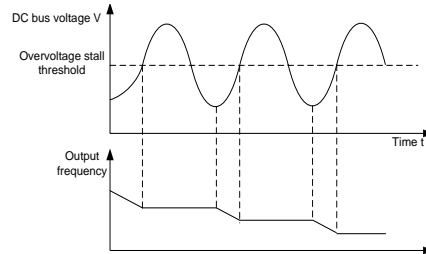
Function code	Name	Detailed parameter description	Default value	Modify
		2. Prohibit the input phase loss protection to enable this function.		
P11.03	Overvoltage stall protection	0: Disable 1: Enable 	1	<input type="radio"/>
P11.04	Overvoltage stall protection voltage	120–150% (standard bus voltage) (400V)	136%	<input type="radio"/>
		120–150% (standard bus voltage) (230V)	120%	
P11.05	Current-limit selection	During accelerated running, as the load is too large, the actual acceleration rate of motor is lower than that of output frequency, if no measures are taken, the inverter may trip due to overcurrent during acceleration. 0x00–0x11 Ones: Current-limit action selection 0: Invalid 1: Always valid Tens: Hardware current-limit overload alarm selection 0: Valid 1: Invalid	01	<input checked="" type="radio"/>
P11.06	Automatic current-limit level	Current-limit protection function detects output current during running, and compares it with the current-limit level defined by P11.06, if it exceeds the current-limit level, the inverter will run at stable	G model: 160.0% P model: 120.0%	<input checked="" type="radio"/>
P11.07	Frequency-drop rate during current limit	frequency during accelerated running, or run in decreased frequency during constant-speed running; if it exceeds the current-limit level continuously, the inverter output frequency will drop continuously until reaching lower limit frequency. When the output current is detected to be lower than the current-limit level again, it will	10.00 Hz/s	<input checked="" type="radio"/>

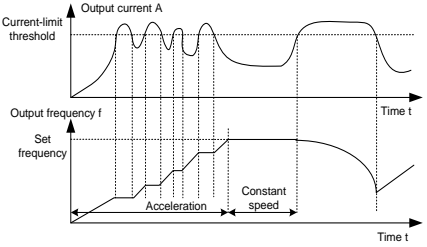
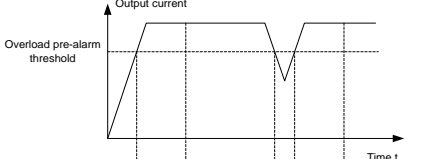
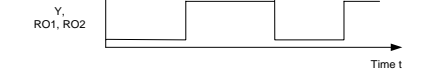
Function code	Name	Detailed parameter description	Default value	Modify
		<p>continue accelerated running.</p>  <p>Setting range of P11.06: 50.0–200.0% Setting range of P11.07: 0.00–50.00Hz/s</p>		
P11.08	Inverter or motor overload/underload pre-alarm	If the inverter or motor output current is larger than the overload pre-alarm detection level (P11.09), and the duration exceeds the overload pre-alarm detection time (P11.10), overload pre-alarm signal will be outputted.	0x000	<input type="radio"/>
P11.09	Overload pre-alarm detection level		G model: 150% P model: 120%	<input type="radio"/>
P11.10	Overload pre-alarm detection time	 <p>Setting range of P11.08: Enable and define overload pre-alarm function of the inverter and motor Setting range: 0x000–0x131 Ones: 0: Motor overload/underload pre-alarm, relative to rated motor current; 1: Inverter overload/underload pre-alarm, relative to rated inverter current. Tens: 0: The inverter continues running after overload/underload alarm;</p>	1.0s	<input type="radio"/>

S1 series standard inverter

Function code	Name	Detailed parameter description	Default value	Modify
		<p>1: The inverter continues running after underload alarm, and stops running after overload fault;                      2: The inverter continues running after overload alarm, and stops running after underload fault;                      3: The inverter stops running after overload/underload fault.</p> <p>Hundreds:                      0: Always detect                      1: Detect during constant-speed running</p> <p>Setting range of P11.09: P11.11–200%                      Setting range of P11.10: 0.1–3600.0s</p>		
P11.11	Underload pre-alarm detection level	Underload pre-alarm signal will be outputted if the output current of the inverter or motor is lower than underload pre-alarm detection level (P11.11), and the duration exceeds underload pre-alarm detection time (P11.12).	50%	<input type="radio"/>
P11.12	Underload pre-alarm detection time	Setting range of P11.11: 0– P11.09 Setting range of P11.12: 0.1–3600.0s	1.0s	<input type="radio"/>
P11.13	Fault output terminal action during fault	<p>This function code is used to set the action of fault output terminals during undervoltage and fault reset.</p> <p>0x00–0x11</p> <p>Ones:                      0: Act during undervoltage fault                      1: Do not act during undervoltage fault</p> <p>Tens:                      0: Act during fault reset                      1: Do not act during fault reset</p>	0x00	<input type="radio"/>
P11.14	Speed deviation detection value	<p>0.0–50.0%</p> <p>This parameter is used to set the speed deviation detection value.</p>	10.0%	<input type="radio"/>
P11.15	Speed deviation detection time	<p>This parameter is used to set the speed deviation detection time.</p> <p><b>Note:</b> Speed deviation protection will be invalid if P11.15 is set to 0.0.</p>	2.0s	<input type="radio"/>

Function code	Name	Detailed parameter description	Default value	Modify
		<p>Setting range: 0.0–10.0s</p>		
<b>P12 group Parameters of motor 2</b>				
P12.01	Rated power of asynchronous motor 2	0.1–3000.0kW	Depend on model	☉
P12.02	Rated frequency of asynchronous motor 2	0.01Hz–P00.03 (Max. output frequency)	50.00Hz	☉
P12.03	Rated speed of asynchronous motor 2	1–36000rpm	Depend on model	☉
P12.04	Rated voltage of asynchronous motor 2	0–1200V	Depend on model	☉
P12.05	Rated current of asynchronous motor 2	0.8–6000.0A	Depend on model	☉
P12.06	Stator resistance of asynchronous motor 2	0.001–65.535Ω	Depend on model	○
P12.07	Rotor resistance of asynchronous motor 2	0.001–65.535Ω	Depend on model	○
P12.08	Leakage inductance of asynchronous motor 2	0.1–6553.5mH	Depend on model	○
P12.09	Mutual inductance of asynchronous	0.1–6553.5mH	Depend on model	○

S1 series standard inverter

Function code	Name	Detailed parameter description	Default value	Modify
	motor 2			
P12.10	No-load current of asynchronous motor 2	0.1–6553.5A	Depend on model	○
P12.11	Magnetic saturation coefficient 1 of iron core of asynchronous motor 2	0.0–100.0%	80%	○
P12.12	Magnetic saturation coefficient 2 of iron core of asynchronous motor 2	0.0–100.0%	68%	○
P12.13	Magnetic saturation coefficient 3 of iron core of asynchronous motor 2	0.0–100.0%	57%	○
P12.14	Magnetic saturation coefficient 4 of iron core of asynchronous motor 2	0.0–100.0%	40%	○
P12.24	Reserved	0–0xFFFF	0x0000	●
P12.25	Reserved	0%–50% (of the rated current of the motor)	10%	●
P12.26	Overload protection of motor 2	0: No protection 1: Common motor (with low-speed compensation) 2: Frequency-variable motor (without low-speed compensation)	2	◎
P12.27	Overload protection coefficient of motor 2	Motor overload multiples $M = I_{out}/(I_n \times K)$ $I_n$ is rated motor current, $I_{out}$ is inverter output current, $K$ is motor overload protection coefficient. The smaller the $K$ , the larger the value of $M$ , the	100.0%	○

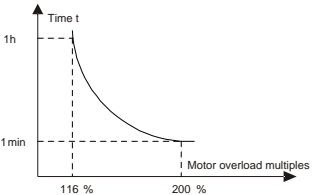

Function code	Name	Detailed parameter description	Default value	Modify
		<p>easier the protection.</p> <p>if M is 116%, protection will be applied when motor overloads for 1h; if M is 200%, protection will be applied when motor overloads for 60s; if M is no less than 400%, protection will be applied immediately.</p>  <p>Setting range: 20.0%–120.0%</p>		
P12.28	Power display calibration coefficient of motor 2	0.00–3.00	1.00	<input type="radio"/>
P12.29	System inertia of motor 2	0–30.000kgm <sup>2</sup>	0.000	<input type="radio"/>
<b>P14 group Serial communication function</b>				
P14.00	Local communication address	<p>Setting range: 1–247</p> <p>When the master is writing frames, and the slave communication address is set to 0, it is the broadcast communication address, and all the slaves on the Modbus bus will accept this frame, but the slave never responds.</p> <p>Local communication address is unique in the communication network, which is the basis for point-to-point communication between the upper computer and the inverter.</p> <p><b>Note:</b> The slave address cannot be set to 0.</p>	1	<input type="radio"/>
P14.01	Communication baud rate setup	<p>This parameter is used to set the data transmission speed between upper computer and the inverter.</p> <p>0: 1200BPS 1: 2400BPS 2: 4800BPS 3: 9600BPS</p>	4	<input type="radio"/>

S1 series standard inverter

Function code	Name	Detailed parameter description	Default value	Modify
		4: 19200BPS 5: 38400BPS 6: 57600BPS 7: 115200BPS <b>Note:</b> Baud rate of the upper computer must be the same with the inverter; otherwise, communication cannot be performed. The larger the baud rate, the faster the communication speed.		
P14.02	Data bit check setup	The data format of upper computer must be the same with the inverter; otherwise, communication cannot be performed. 0: No parity check (N, 8, 1) for RTU 1: Even parity (E, 8, 1) for RTU 2: Odd parity (O, 8, 1) for RTU 3: No parity check (N, 8, 2) for RTU 4: Even parity (E, 8, 2) for RTU 5: Odd parity (O, 8, 2) for RTU	1	○
P14.03	Communication response delay	0–200ms It refers to the time interval from when the data is received by the inverter to the moment when the data is sent to the upper computer. If the response delay is less than the system processing time, the response delay will be subject to system processing time; if the response delay is longer than the system processing time, data will be sent to the upper computer at a delay after data process is done by system.	5	○
P14.04	Communication timeout period	0.0 (invalid) –60.0s This parameter will be invalid if it is set to 0.0; When it is set to a non-zero value, if the time interval between current communication and the next communication exceeds the communication timeout period, the system will report "485 communication fault" (CE). Under common situations, it is set to 0.0. In systems which have continuous communication, users can monitor the communication condition by setting this parameter.	0.0s	○

S1 series standard inverter

Function code	Name	Detailed parameter description	Default value	Modify
P14.05	Transmission error processing	0: Alarm and coast to stop 1: Do not alarm and continue running 2: Do not alarm and stop as per the stop mode (under communication control mode only) 3: Do not alarm and stop as per the stop mode (under all control modes)	0	○
P14.06	Communication processing action	0x00–0x11 Ones: 0: Write operation has response 1: Write operation has no response Tens: 0: Communication password protection is invalid 1: Communication password protection is valid	0x00	○
<b>P17 group State-check function</b>				
P17.00	Set frequency	Display current set frequency of the inverter. Range: 0.00Hz–P00.03	50.00Hz	●
P17.01	Output frequency	Display current output frequency of the inverter. Range: 0.00Hz–P00.03	0.00Hz	●
P17.02	Ramps reference frequency	Display current ramps reference frequency of the inverter. Range: 0.00Hz–P00.03	0.00Hz	●
P17.03	Output voltage	Display current output voltage of the inverter. Range: 0–1200V	0V	●
P17.04	Output current	Display the valid value of current output current of the inverter. Range: 0.0–5000.0A	0.0A	●
P17.05	Motor speed	Display current motor speed. Range: 0–65535RPM	0 RPM	●
P17.06	Torque current	Display current torque current of the inverter. Range: -3000.0–3000.0A	0.0A	●
P17.07	Exciting current	Display current exciting current of the inverter. Range: -3000.0–3000.0A	0.0A	●
P17.08	Motor power	Display current motor power; 100% relative to rated motor power, positive value is motoring state, negative value is generating state. Range: -300.0–300.0% (relative to rated motor power)	0.0%	●
P17.09	Motor output	Display current output torque of the inverter;	0.0%	●

S1 series standard inverter

Function code	Name	Detailed parameter description	Default value	Modify
	torque	100% relative to rated motor torque, during forward running, positive value is motoring state, negative value is generating state, during reverse running, positive value is generating state, negative value is motoring state. Range: -250.0–250.0%		
P17.10	Estimated motor frequency	The estimated motor rotor frequency under open-loop vector condition. Range: 0.00–P00.03	0.00Hz	●
P17.11	DC bus voltage	Display current DC bus voltage of the inverter. Range: 0.0–2000.0V	0V	●
P17.12	Digital input terminal state	Display current digital input terminal state of the inverter. 0000–03F Corresponds to HDIB, HDIA, S4, S3, S2 and S1 respectively	0	●
P17.13	Digital output terminal state	Display current digital output terminal state of the inverter. 0000–000F Corresponds to R02, RO1, HDO and Y1 respectively	0	●
P17.14	Digital adjustment variable	Display the regulating variable by <u>UP/DOWN</u> terminals of the inverter. Range: 0.00Hz–P00.03	0.00Hz	●
P17.15	Torque reference value	Relative to percentage of the rated torque of current motor, display torque reference. Range: -300.0%–300.0% (rated motor current)	0.0%	●
P17.16	Linear speed	0–65535	0	●
P17.17	Reserved	0–65535	0	●
P17.18	Count value	0–65535	0	●
P17.19	AI1 input voltage	Display input signal of AI 1 Range: 0.00–10.00V	0.00V	●
P17.20	AI2 input voltage	Display input signal of AI2 Range: -10.00V–10.00V	0.00V	●
P17.21	HDIA input frequency(AI3 input voltage, model<4kW)	Display input frequency of HDIA Range: 0.000–50.000kHz Note: up to 2.2kW, P17.21=AI3 input voltage	0.000 kHz	●

S1 series standard inverter

Function code	Name	Detailed parameter description	Default value	Modify
P17.22	HDI/HDIB input frequency	Display input frequency of HDIB Range: 0.000–50.000kHz Note: up to 2.2kW, P17.22=HDI input frequency	0.000 kHz	●
P17.23	PID reference value	Display PID reference value Range: -100.0–100.0%	0.0%	●
P17.24	PID feedback value	Display PID feedback value Range: -100.0–100.0%	0.0%	●
P17.25	Motor power factor	Display the power factor of current motor. Range: -1.00–1.00	1.00	●
P17.26	Current running time	Display current running time of the inverter. Range: 0–65535min	0m	●
P17.27	Current step number of multi-step speed	Current step number of multi-step speed Range: 0–15	0	●
P17.28	Motor ASR controller output	Display the speed loop ASR controller output value under vector control mode, relative to the percentage of rated torque of the motor. Range: -300.0%–300.0% (rated motor current)	0.0%	●
P17.32	Motor flux linkage	0.0%–200.0%	0.0%	●
P17.33	Exciting current reference	Display the exciting current reference value under vector control mode Range: -3000.0–3000.0A	0.0A	●
P17.34	Torque current reference	Display torque current reference value under vector control mode Range: -3000.0–3000.0A	0.0A	●
P17.35	AC incoming current	Display the valid value of incoming current on AC side Range: 0.0–5000.0A	0.0A	●
P17.36	Output torque	Display output torque value, during forward running, positive value is motoring state, negative value is generating state; during reverse running, positive value is generating state, negative value is motoring state. Range: -3000.0Nm–3000.0Nm	0.0Nm	●
P17.37	Motor overload count value	0–65535	0	●
P17.38	Process PID output	-100.0%–100.0%	0.00%	●

Function code	Name	Detailed parameter description	Default value	Modify
<b>P28 group AIAO calibration function</b>				
P28.00	Password	00000	****	<input type="radio"/>
P28.01	AD sampling value of AI1 input voltage	0-4095	0	<input checked="" type="radio"/>
P28.02	AI1 given voltage 1	-0.5-4.00V	0.00V	<input type="radio"/>
P28.03	AD sampling value of AI1 given voltage 1	0-4095	0	<input type="radio"/>
P28.04	AI1 given voltage 2	6.00-10.50V	10.00V	<input type="radio"/>
P28.05	AD sampling value of AI1 given voltage 2	0-4095	0	<input type="radio"/>
P28.06	AD sampling value of AI1 input current	0-4095	0	<input checked="" type="radio"/>
P28.07	AI1 given current 1	-1.00-8.00mA	0.00mA	<input type="radio"/>
P28.08	AD sampling value of AI1 given current 1	0-4095	0	<input type="radio"/>
P28.09	AI1 given current 2	12.00-21.00mA	20mA	<input type="radio"/>
P28.10	AD sampling value of AI1 given current 2	0-4095	0	<input type="radio"/>
P28.11	AD sampling value of AI2 input voltage	0.00-10.00s	0.00s	<input checked="" type="radio"/>
P28.12	AI2 given voltage 1	-10.50-1.00V	-10.00V	<input type="radio"/>
P28.13	AD sampling value of AI2 given voltage 1	0-4095	0	<input type="radio"/>
P28.14	AI2 given voltage 2	4.00-10.50V	10.00V	<input type="radio"/>

S1 series standard inverter

Function code	Name	Detailed parameter description	Default value	Modify
P28.15	AD sampling value of AI2 given voltage 2	0-4095	0	<input type="radio"/>
P28.16	AD sampling value of AI3 input voltage	0.00-10.00s	0.00s	<input checked="" type="radio"/>
P28.17	AI3 given voltage 1	-10.00-1.00V	-10.00V	<input type="radio"/>
P28.18	AD sampling value of AI3 given voltage 1	0-4095	0	<input type="radio"/>
P28.19	AI3 given voltage 2	4.00-10.50V	10.00V	<input type="radio"/>
P28.20	AD sampling value of AI3 given voltage 2	0-4095	0	<input type="radio"/>
P28.21	Actual voltage value of AO1 relative to 0V	-1.000-12.500V	-0.200V	<input type="radio"/>
P28.22	Actual voltage value of AO1 relative to 10V	-1.000-12.500V	10.250V	<input type="radio"/>
P28.23	Actual voltage value of AO1 relative to 0mA	-1.000-12.500V	-0.200V	<input type="radio"/>
P28.24	Actual voltage value of AO1 relative to 20mA	-1.000-12.500V	10.250V	<input type="radio"/>
<b>P29 group Factory function</b>				
P29.00	Password	0-65535	****	<input type="radio"/>
P29.01	Reserved	0-1	0-1	<input checked="" type="radio"/>
P29.02	Inverter type	0-33	Depend on model	<input type="radio"/>
P29.03	Inverter rated power	0.4-3000.0kW	Depend on model	<input checked="" type="radio"/>
P29.04	Inverter rated	0-1200V	Depend	<input type="radio"/>

S1 series standard inverter

Function code	Name	Detailed parameter description	Default value	Modify
	voltage		on model	
P29.05	Inverter rated current	0.0–6000.0A	Depend on model	●
P29.06	Dead timezone	2.0us–15.0us	Depend on model	◎
P29.07	Over-voltage point	0.0V–2500.0V	Depend on model	◎
P29.08	Under-voltage point	0.0V–2000.0V	Depend on mode	◎
P29.09	Over-current point	10.0%–250.0%	220.0%	◎
P29.10	Voltage calibration coefficient	10.0%–250.0%	100.0%	◎
P29.11	Current calibration coefficient	10.0%–250.0%	100.0%	◎
P29.12	Factory time setting	0–65535h	0h	○



## Chapter 7 Troubleshooting

### 7.1 What this chapter contains

The chapter tells users how to reset faults and check faults history. A complete list of alarms and fault information as well as possible causes and corrective measures are presented in this chapter.



⚡ Only well-trained and qualified professionals are allowed to carry out the work described in this chapter. Operations should be carried out according to the instructions presented in chapter 1 "Safety precautions".

### 7.2 Indications of alarms and faults

The fault is indicated by indicators (refer to the "Keypad operation process"). When **TRIP** indicator is on, the alarm or fault code displayed in the keypad indicates the inverter is in exception state. This chapter covers most of the alarms and faults, and their possible causes and corrective measures, if users cannot figure out the alarm or fault causes, contact local HITACHI office.

### 7.3 Fault reset

Users can reset the inverter via **STOP/RST** key on the keypad, digital inputs, or by cutting off the inverter power. After faults are removed, the motor can be start again.

### 7.4 Fault history

P07.27–P07.32 record the six latest fault types; P07.33–P07.40, P07.41–P07.48, and P07.49–P07.56 record the running data of the inverter when the latest three faults occurred.

### 7.5 Inverter faults and solutions

When fault occurred, process the fault as shown below.

1. When inverter fault occurred, confirm whether keypad display is improper? If yes, contact HITACHI;
2. If keypad works properly, check the function codes in P07 group to confirm the corresponding fault record parameters, and determine the real state when current fault occurred through parameters;
3. Check the table below to see whether corresponding exception states exist based on the corresponding corrective measures;
4. Rule out the faults or ask for help from professionals;
5. After confirming faults are removed, reset the fault and start running.

#### 7.5.1 Details of faults and solutions

Fault code	Fault type	Possible cause	Corrective measures
OUt1	Inverter unit Phase-U protection	Acceleration is too fast; IGBT module is damaged;	Increase acceleration time; Replace the power unit;
OUt2	Inverter unit Phase-V protection	Misacts caused by interference; drive wires are	Check drive wires; Check whether there is strong
OUt3	Inverter unit	poorly connected ;	interference surrounds the

S1 series standard inverter

<b>Fault code</b>	<b>Fault type</b>	<b>Possible cause</b>	<b>Corrective measures</b>
	Phase-W protection	To-ground short circuit occurs	peripheral equipment
OV1	Over-voltage during acceleration	Exception occurred to input voltage; Large energy feedback; Lack of brake units; Dynamic brake is not enabled	Check input power; Check whether load deceleration time is too short; or the motor starts during rotating; Install dynamic brake units; Check the setup of related function codes
OV2	Over-voltage during deceleration		
OV3	Over-voltage during constant speed running		
OC1	Over-current during acceleration	Acceleration is too fast; Grid voltage is too low; Inverter power is too small; Load transient or exception occurred; To-ground short circuit or output phase loss occur; Strong external interference sources; Overvoltage stall protection is not enabled	Increase acceleration /deceleration time; Check input power; Select the inverter with larger power; Check if the load is short circuited (to-ground short circuit or line-to-line short circuit) or the rotation is not smooth; Check the output wiring; Check if there is strong interference; Check the setup of related function codes.
OC2	Over-current during deceleration		
OC3	Over-current during constant speed running		
UV	Bus undervoltage fault	Grid voltage is too low; Overvoltage stall protection is not enabled	Check grid input power; Check the setup of related function codes
OL1	Motor overload	Grid voltage is too low; Rated motor current is set improperly; Motor stall or load jumps violently	Check grid voltage; Reset rated motor current; Check the load and adjust torque boost
OL2	Inverter overload	Acceleration is too fast; The motor in rotating is restarted; Grid voltage is too low; Load is too large; Power is too small;	Increase acceleration time; Avoid restart after stop; Check grid voltage; Select the inverter with larger power; Select proper motor

S1 series standard inverter

<b>Fault code</b>	<b>Fault type</b>	<b>Possible cause</b>	<b>Corrective measures</b>
SPI	Phase loss on input side	Phase loss or violent fluctuation occurred to R, S and T input	Check the input power; Check installation wiring
SPO	Phase loss on output side	Phase loss occurred to U, V, W output (or the three phases of motor is asymmetrical)	Check the output wiring; Check the motor and cable
OH1	Overheat of rectifier module	Air duct is blocked or fan is damaged;	Ventilate the air duct or replace the fan; Lower the ambient temperature
OH2	Overheat of inverter module	Ambient temperature is too high; Long-time overload running	
EF	External fault	External fault input terminal acts	Check external device input
CE	485 communication fault	Baud rate is set improperly; Communication line fault; Communication address error; Communication suffers from strong interference	Set proper baud rate; Check the wiring of communication interfaces; Set proper communication address; Replace or change the wiring to enhance anti-interference capacity
ItE	Current detection fault	Poor contact of the connector of control board; Hall component is damaged; Exception occurred to amplification circuit	Check the connector and re-plug; Replace the hall component; Replace the main control board
tE	Motor autotuning fault	Motor capacity does not match with the inverter capacity, this fault may occur easily if the difference between them is exceeds five power classes; Motor parameter is set improperly; The parameters gained from autotuning deviate sharply from the standard parameters;	Change the inverter model, or adopt V/F mode for control; Set proper motor type and nameplate parameters; Empty the motor load and carry out autotuning again; Check motor wiring and parameter setup; Check whether upper limit frequency is larger than 2/3 of the rated frequency

Fault code	Fault type	Possible cause	Corrective measures
		Autotuning timeout	
EEP	EEPROM fault	R/W error occurred to the control parameters; EEPROM is damaged	Press <b>STOP/RST</b> to reset; Replace the main control board
PIDE	PID feedback offline fault	PID feedback offline; PID feedback source disappears;	Check PID feedback signal wires; Check PID feedback source
bCE	Brake unit fault	Brake circuit fault or brake tube is damaged; The resistance of external brake resistor is too small	Check the brake unit, replace with new brake tubes; Increase brake resistance
END	Running time is up	The actual running time of the inverter is larger than the set running time	Ask help from the supplier, adjust the set running time
OL3	Electronic overload fault	The inverter releases overload pre-alarm based on the set value	Check the load and overload pre-alarm threshold
PCE	Keypad communication fault	The keypad wire is poorly contacted or disconnected; The keypad wire is too long and suffers strong interference; Circuit fault occurred to the keypad or communication part of the main board	Check the keypad wires to confirm whether fault exists; Check the surroundings to rule out interference source; Replace the hardware and ask for maintenance service
UPE	Parameter upload error	The keypad wire is poorly contacted or disconnected; The keypad wire is too long and suffers strong interference; Circuit fault occurred to the keypad or communication part of the main board	Check the surroundings to rule out interference source; Replace the hardware and ask for maintenance service; Replace the hardware and ask for maintenance service
DNE	Parameter download error	The keypad wire is poorly contacted or disconnected; The keypad wire is too long and suffers strong interference;	Check the surroundings to rule out interference source; Replace the hardware and ask for maintenance service; Re-backup keypad data

S1 series standard inverter

<b>Fault code</b>	<b>Fault type</b>	<b>Possible cause</b>	<b>Corrective measures</b>
		Data storage error occurred to the keypad	
ETH1	To-ground short circuit fault 1	Inverter output is short connected to the ground; Current detection circuit is faulty; Actual motor power setup deviates sharply from the inverter power	Check whether motor wiring is proper; Replace the hall component; Replace the main control board; Reset the motor parameters properly
ETH2	To-ground short circuit fault 1	Inverter output is short connected to ground; Current detection circuit is faulty; Actual motor power setup deviates sharply from the inverter power	Check whether motor wiring is proper; Replace the hall component; Replace the main control board; Reset the motor parameters properly
LL	Electronic underload fault	The inverter performs underload pre-alarm based on the set value	Check the load and overload pre-alarm threshold
STO	Safe torque off	Safe torque off function is enabled by external forces	/
STL1	Exception occurred to safe circuit of channel H1	The wiring of STO is improper; Fault occurred to external switch of STO; Hardware fault occurred to safety circuit of channel H1	Check whether terminal wiring of STO is proper and firm enough; Check whether external switch of STO can work properly; Replace the control board
STL2	Exception occurred to channel H2 safe circuit	The wiring of STO is improper; Fault occurred to external switch of STO; Hardware fault occurred to safety circuit of channel H2	Check whether terminal wiring of STO is proper and firm enough; Check whether external switch of STO can work properly; Replace the control board
STL3	Exception occurred to channel H1 and channel H2	Hardware fault occurred to STO circuit	Replace the control board
CrCE	Safety code FLASH CRC check fault	Control board is faulty	Replace the control board

7.5.2 Other state

Displayed code	State type	Possible cause	Solution
PoFF	System power failure	The system is powered off or the bus voltage is too low.	Check the grid conditions.

**Note:** After set the RO terminal function as function 5 (inverter fault), it will send the signal to the contactor to cut off the input power when inverter reports ETH (ground short circuit fault) or other faults.

7.6 Analysis on common faults

7.6.1 Motor fails to work

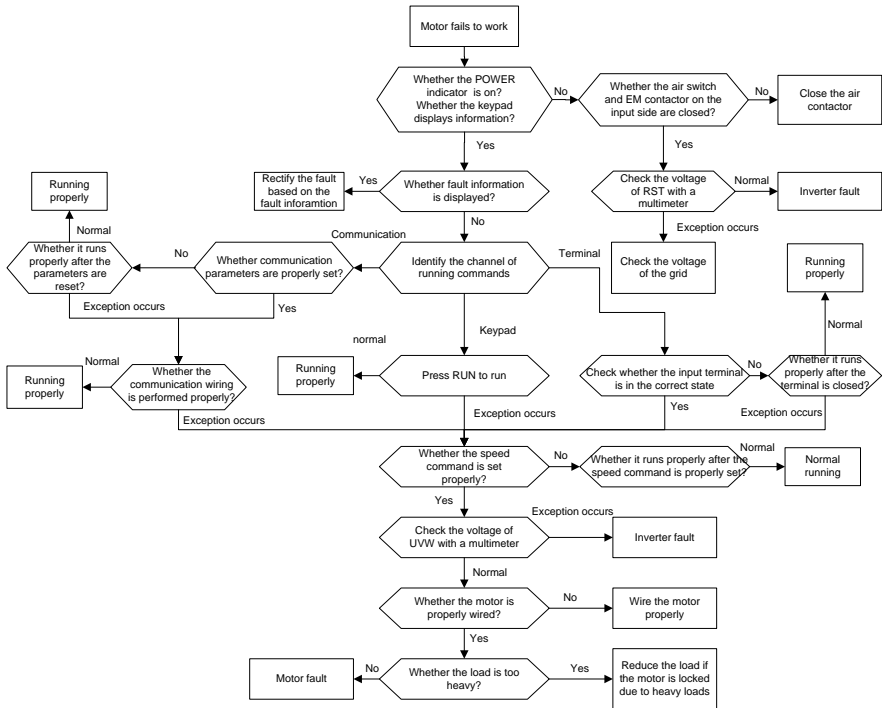

7.6.2 Motor vibrates

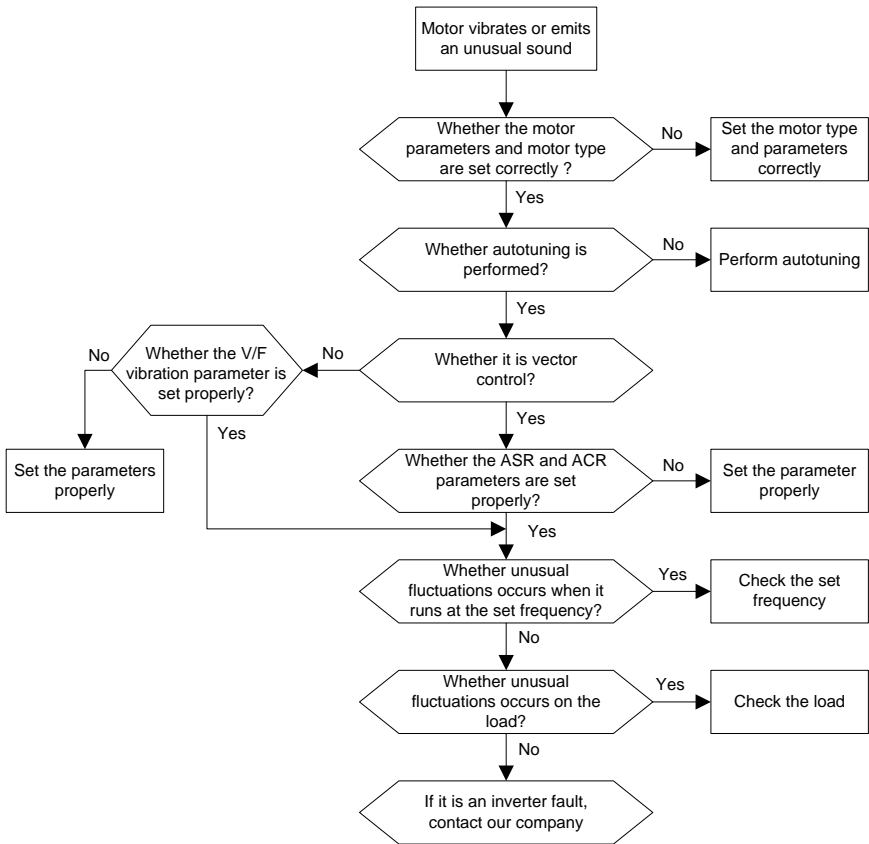

7.6.3 Overvoltage

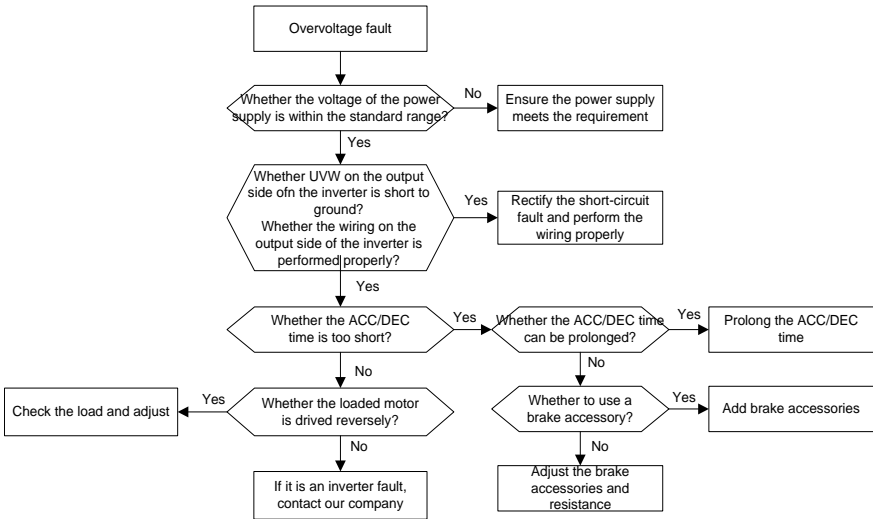

7.6.4 Undervoltage

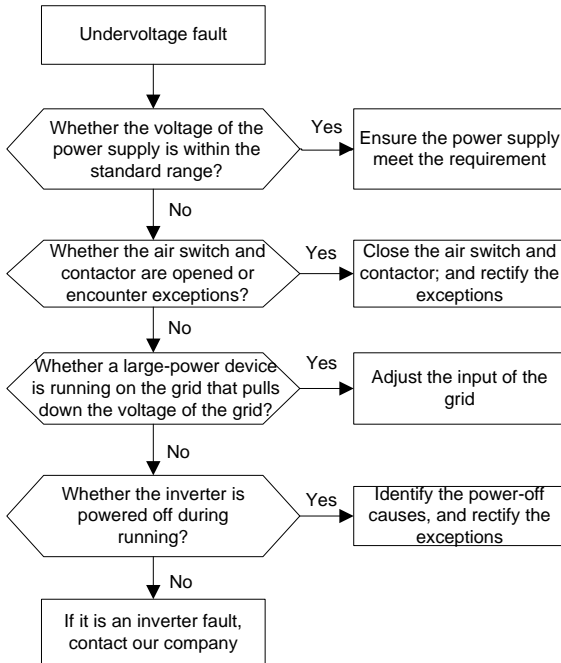



### 7.6.5 Unusual heating of motor

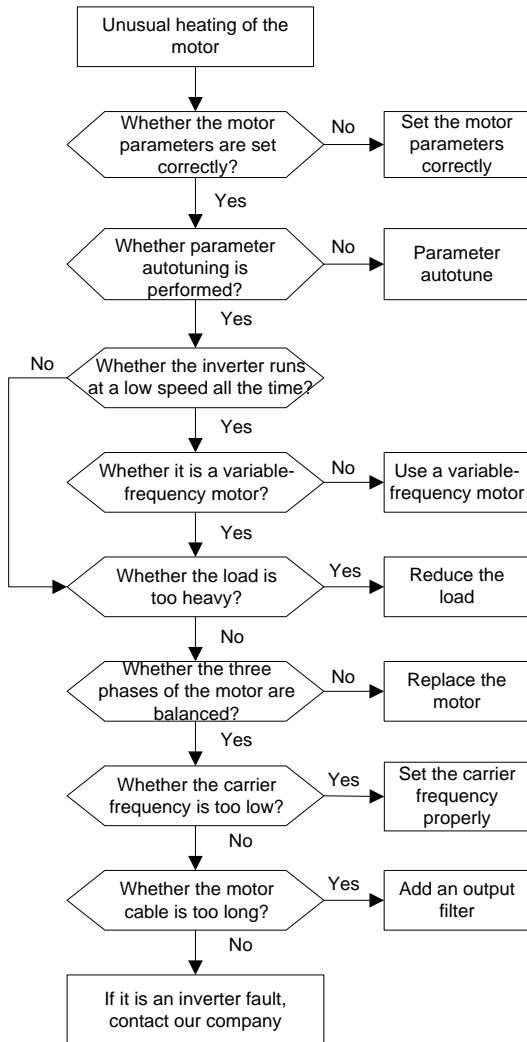

### 7.6.6 Inverter overheating

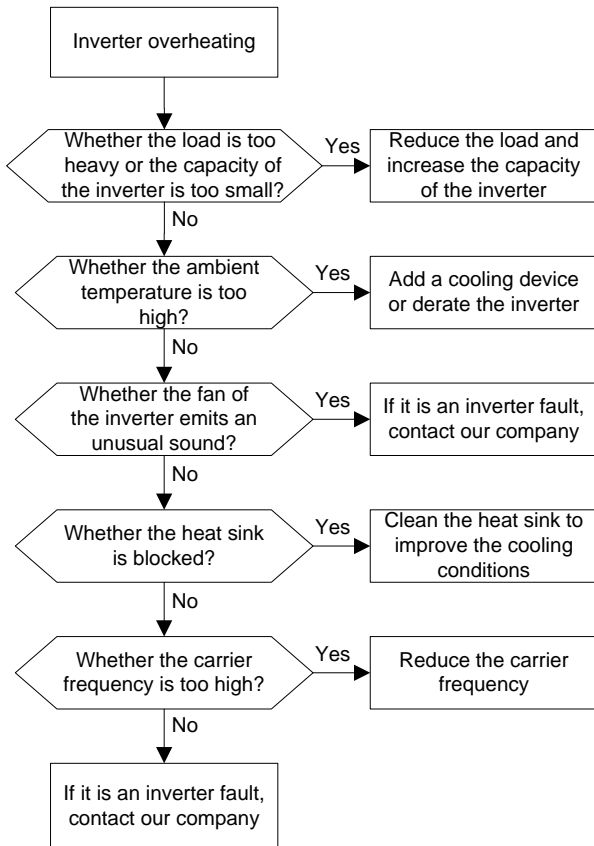

7.6.7 Motor stalls during ACC

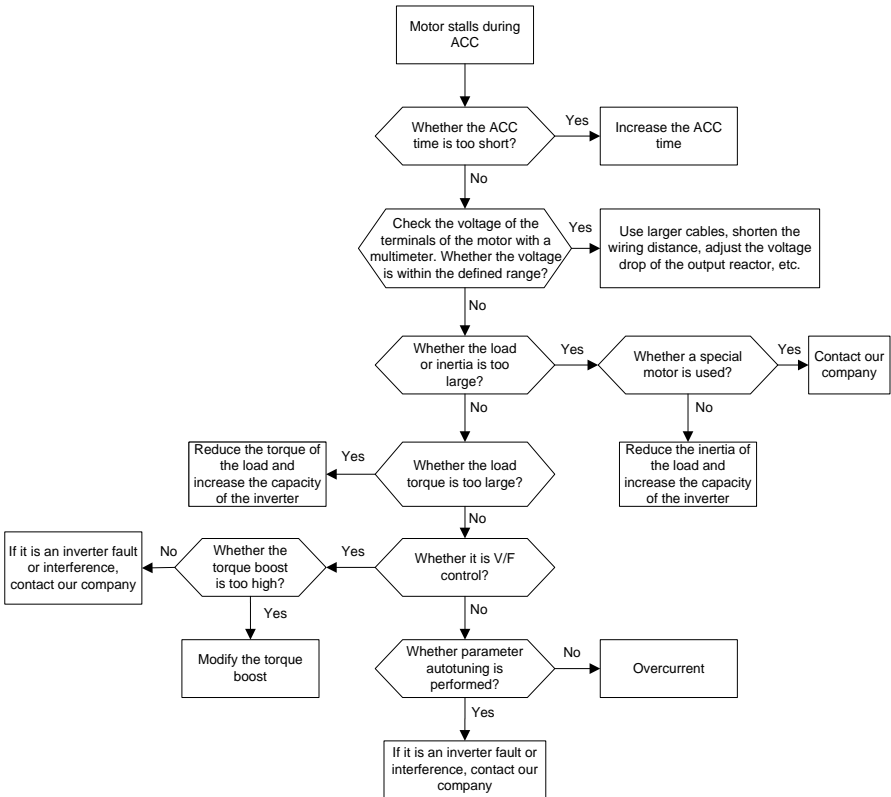

7.6.8 Overcurrent

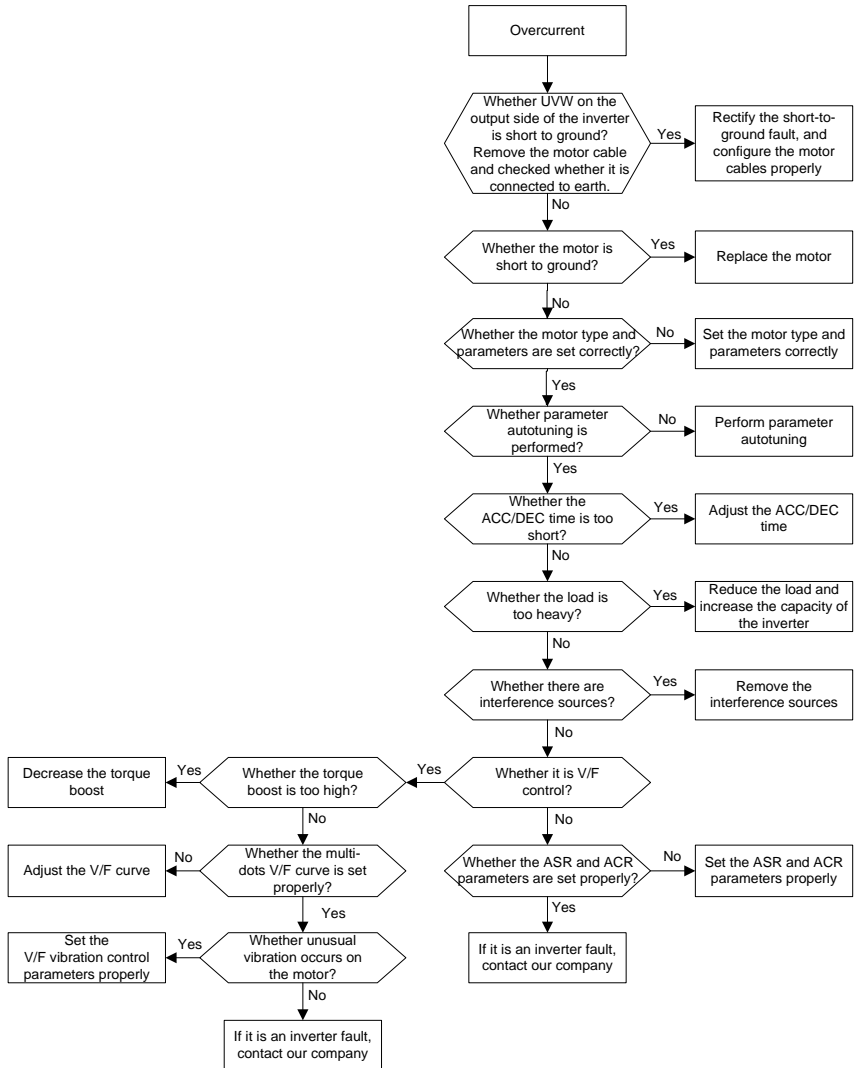

## **7.7 Countermeasures on common interference**

### **7.7.1 Interference on meter switches and sensors**

#### **Interference phenomenon**

Pressure, temperature, displacement, and other signals of a sensor are collected and displayed by a human-machine interaction device. The values are incorrectly displayed as follows after the inverter is started:

1. The upper or lower limit is wrongly displayed, for example, 999 or -999.
2. The display of values jumps (usually occurring on pressure transmitters).
3. The display of values is stable, but there is a large deviation, for example, the temperature is dozens of degrees higher than the common temperature (usually occurring on thermocouples).
4. A signal collected by a sensor is not displayed but functions as a drive system running feedback signal. For example, an inverter is expected to decelerate when the upper pressure limit of the compressor is reached, but in actual running, it starts to decelerate before the upper pressure limit is reached.
5. After an inverter is started, the display of all kinds of meters (such as frequency meter and current meter) that are connected to the analog output (AO) terminal of the inverter is severely affected, displaying the values incorrectly.
6. Proximity switches are used in the system. After an inverter is started, the indicator of a proximity switch flickers, and the output level flips.

#### **Solution**

1. Check and ensure that the feedback cable of the sensor is 20 cm or farther away from the motor cable.
2. Check and ensure that the ground wire of the motor is connected to the PE terminal of the inverter (if the ground wire of the motor has been connected to the ground block, you need to use a multimeter to measure and ensure that the resistance between the ground block and PE terminal is lower than 1.5  $\Omega$ ).
3. Try to add a safety capacitor of 0.1  $\mu\text{F}$  to the signal end of the feedback signal terminal of the sensor.
4. Try to add a safety capacitor of 0.1  $\mu\text{F}$  to the power end of the sensor meter (pay attention to the voltage of the power supply and the voltage endurance of the capacitor).
5. For interference on meters connected to the AO terminal of an inverter, if AO uses current signals of 0 to 20 mA, add a capacitor of 0.47  $\mu\text{F}$  between the AO and GND terminals; and if AO uses voltage signals of 0 to 10 V, add a capacitor of 0.1  $\mu\text{F}$  between the AO and GND terminals.

#### **Note:**

1. When a decoupling capacitor is required, add it to the terminal of the device connected to the sensor. For example, if a thermocouple is to transmit signals of 0 to 20 mA to a temperature meter,

the capacitor needs to be added on the terminal of the temperature meter.; if an electronic ruler is to transmit signals of 0 to 30 V to a PLC signal terminal, the capacitor needs to be added on the terminal of the PLC.

2. If a large number of meters or sensors are disturbed. It is recommended that you configure an external C2 filter on the input power end of the inverter.

### **7.7.2 Interference on communication**

#### **Interference phenomenon**

The interference described in this section on 485 communication mainly includes communication delay, out of sync, occasional power-off, or complete power-off that occurs after an inverter is started.

If the communication cannot be implemented properly, regardless of whether the inverter is running, the exception is not necessarily caused by interference. You can find out the causes as follows:

1. Check whether the 485 communication bus is disconnected or in poor contact.
2. Check whether the two ends of line A or B are connected reversely.
3. Check whether the communication protocol (such as the baud rate, data bits, and check bit) of the inverter is consistent with that of the upper computer.

If you are sure that communication exceptions are caused by interference, you can resolve the problem through the following measures:

1. Simple inspection.
2. Arrange the communication cables and motor cables in different cable trays.
3. In multi-inverter application scenarios, adopt the chrysanthemum connection mode to connect the communication cables between inverters, which can improve the anti-interference capability.
4. In multi-inverter application scenarios, check and ensure that the driving capacity of the master is sufficient.
5. In the connection of multiple inverters, you need to configure one 120  $\Omega$  terminal resistor on each end.

#### **Solution**

1. Check and ensure that the ground wire of the motor is connected to the PE terminal of the inverter (if the ground wire of the motor has been connected to the ground block, you need to use a multimeter to measure and ensure that the resistance between the ground block and PE terminal is lower than 1.5  $\Omega$ ).
2. Do not connect the inverter and motor to the same ground terminal as the upper computer. It is recommended that you connect the inverter and motor to the power ground, and connect the upper computer separately to a ground stud.
3. Try to short the signal reference ground terminal (GND) of the inverter with that of the upper computer controller to ensure that ground potential of the communication chip on the control board of the inverter is consistent with that of the communication chip of the upper computer.

4. Try to short GND of the inverter to its ground terminal (PE).
5. Try to add a safety capacitor of 0.1  $\mu\text{F}$  on the power terminal of the upper computer (PLC, HMI, and touch screen). During this process, pay attention to the voltage of the power supply and the voltage endurance capability of the capacitor. Alternatively, you can use a magnet ring (Fe-based nanocrystalline magnet rings are recommended). Put the power L/N line or +/- line of the upper computer through the magnet ring in the same direction and wind 8 coils around the magnet ring.

### 7.7.3 Failure to stop and indicator shimmering due to motor cable coupling

#### Interference phenomenon

1. Failure to stop

In an inverter system where an S terminal is used to control the start and stop, the motor cable and control cable are arranged in the same cable tray. After the system is started properly, the S terminal cannot be used to stop the inverter.

2. Indicator shimmering

After an inverter is started, the relay indicator, power distribution box indicator, PLC indicator, and indication buzzer shimmers, blinks, or emits unusual sounds unexpectedly.

#### Solution

1. Check and ensure that the exception signal cable is arranged 20 cm or farther away from the motor cable.
2. Add a safety capacitor of 0.1  $\mu\text{F}$  between the digital input terminal (S) and the COM terminal.
3. Connect the digital input terminal (S) that controls the start and stop to other idle digital input terminals in parallel. For example, if S1 is used to control the start and stop and S4 is idle, you can try to connect S1 to S4 in parallel.

**Note:** If the controller (such as PLC) in the system controls more than 5 inverters at the same time through digital input terminals (S), this scheme is not available.

### 7.7.4 Leakage current and interference on RCD

Inverters output high-frequency PWM voltage to drive motors. In this process, the distributed capacitance between the internal IGBT of an inverter and the heat sink and that between the stator and rotor of a motor may inevitably cause the inverter to generate high-frequency leakage current to the ground. A residual current operated protective device (RCD) is used to detect the power-frequency leakage current when a grounding fault occurs on a circuit. The application of an inverter may cause misoperation of a RCD.

1. Rules for selecting RCDs

- (1) Inverter systems are special. In these systems, it is required that the rated residual current of common RCDs at all levels is larger than 200 mA, and the inverters are grounded reliably.
- (2) For RCDs, the time limit of an action needs to be longer than that of a next action, and the time difference between two actions need to be longer than 20 ms. For example, 1s, 0.5s, and 0.2s.
- (3) For circuits in inverter systems, electromagnetic RCDs are recommended. Electromagnetic

RCDs have strong anti-interference capability, and thus can prevent the impact of high-frequency leakage current.

Electronic RCD	Electromagnetic RCD
<p>Low cost, high sensitivity, small in volume, susceptible to voltage fluctuation of the grid and ambient temperature, weak anti-interference capability</p>	<p>Requiring highly sensitive, accurate, and stable zero-phase sequence current transformer, using permalloy high-permeability materials, complex process, high cost, not susceptible to voltage fluctuation of the power supply and ambient temperature, strong anti-interference capability</p>

2. Solution to RCD misoperation (handling the inverter)

- (1) Try to remove the jumper cap at "EMC/J10" on the middle casing of the inverter.
- (2) Try to reduce the carrier frequency to 1.5 kHz (P00.14=1.5).
- (3) Try to modify the modulation mode to "3PH modulation and 2PH modulation" (P08.40=00).

3. Solution to RCD misoperation (handling the system power distribution)

- (1) Check and ensure that the power cable is not soaking in water.
- (2) Check and ensure that the cables are not damaged or spliced.
- (3) Check and ensure that no secondary grounding is performed on the neutral wire.
- (4) Check and ensure that the main power cable terminal is in good contact with the air switch or contactor (all screws are tightened).
- (5) Check 1PH powered devices, and ensure that no earth lines are used as neutral wires by these devices.
- (6) Do not use shielded cables as inverter power cables and motor cables.

**7.7.5 Live device chassis**

**Phenomenon**

After an inverter is started, there is sensible voltage on the chassis, and you may feel an electric shock when touching the chassis. The chassis, however, is not live (or the voltage is far lower than the human safety voltage) when the inverter is powered on but not running.

**Solution**

- 1. If there is power distribution grounding or ground stud on the site, ground the cabinet chassis of the drive system through the power ground or stud.
- 2. If there is no grounding on the site, you need to connect the motor chassis to the ground terminal PE of the inverter, and ensure that the jumper at "EMC/J10" on the middle casing of the inverter is shorted.



## Chapter 8 Maintenance and hardware fault diagnosis

### 8.1 What this chapter contains

This chapter describes how to carry out preventive maintenance on S1 series inverters.

### 8.2 Periodical inspection

Little maintenance is required when inverters are installed in environments that meet requirements.

The following table describes the routine maintenance periods recommended by HITACHI.

Subject		Item	Method	Criterion
Ambient environment		Check the temperature, and humidity, and whether there is vibration, dust, gas, oil spray, and water droplets in the environment.	Visual inspection, and use instruments for measurement.	The requirements stated in this manual are met.
		Check whether there are foreign matters, such as tools, or dangerous substances placed nearby.	Visual inspection	There are no tools or dangerous substances placed nearby.
Voltage		Check the voltage of the main circuit and control circuit.	Use multimeters or other instruments for measurement.	The requirements stated in this manual are met.
Keypad		Check the display of information.	Visual inspection	The characters are displayed properly.
		Check whether characters are not completely displayed.	Visual inspection	The requirements stated in this manual are met.
Main circuit	Common	Check whether the bolts loose or come off.	Screw them up.	No exception occurs.
		Check whether the machine is deformed, cracked, or damaged, or their color changes due to overheating and aging.	Visual inspection	No exception occurs.
		Check whether there are stains and dust attached.	Visual inspection	No exception occurs. <b>Note:</b> Discoloration of copper bars does not mean that they cannot work properly.

S1 series standard inverter

Subject	Item	Method	Criterion
Conductor and wire	Check whether the conductors are deformed or their color change due to overheat.	Visual inspection	No exception occurs.
	Check whether the wire sheaths are cracked or their color changes.	Visual inspection	No exception occurs.
Terminal block	Check whether there is damage.	Visual inspection	No exception occurs.
Filter capacitor	Check whether there is electrolyte leakage, discoloration, cracks, and chassis expansion.	Visual inspection	No exception occurs.
	Check whether the safety valves are released.	Determine the service life based on the maintenance information, or measure them through electrostatic capacity.	No exception occurs.
	Check whether the electrostatic capacity is measured as required.	Use instruments to measure the capacity.	Electrostatic capacity $\geq$ initial value $\times$ 0.85
Resistor	Check whether there is displacement caused due to overheat.	Olfactory and visual inspection	No exception occurs.
	Check whether the resistors are disconnected.	Visual inspection, or remove one end of the connection cable and use a multimeter for measurement.	Resistance range: $\pm 10\%$ (of the standard resistance)
Transformer and reactor	Check whether there is unusual vibration sounds or smells.	Auditory, olfactory, and visual inspection	No exception occurs.
Electromagnetic contactor and relay	Check whether there are vibration sounds in the workshop.	Auditory inspection	No exception occurs.
	Check whether the contacts	Visual inspection	No exception

S1 series standard inverter

Subject		Item	Method	Criterion
		are in good contact.		occurs.
Control circuit	Control PCB, connector	Check whether the screws and connectors loose.	Screw them up.	No exception occurs.
		Check whether there is unusual smell or discoloration.	Olfactory and visual inspection	No exception occurs.
		Check whether there are cracks, damage, deformation, or rust.	Visual inspection	No exception occurs.
		Check whether there is electrolyte leakage or deformation.	Visual inspection, and determine the service life based on the maintenance information.	No exception occurs.
Cooling system	Cooling fan	Check whether there are unusual sounds or vibration.	Auditory and visual inspection, and turn the fan blades with your hand.	The rotation is smooth.
		Check whether the bolts loose.	Screw them up.	No exception occurs.
		Check whether there is discoloration caused due to overheat.	Visual inspection, and determine the service life based on the maintenance information.	No exception occurs.
	Ventilation duct	Check whether there are foreign matters blocking or attached to the cooling fan, air inlets, or air outlets.	Visual inspection	No exception occurs.

For more details about maintenance, contact the local HITACHI office, or visit our website <http://www.hitachi-industrial.com>.

### 8.3 Cooling fan

The service life of the cooling fan of the inverter is more than 25,000 hours. The actual service life of the cooling fan is related to the use of the inverter and the temperature in the ambient environment.

You can view the running duration of the inverter through P07.14 (Accumulated running time).

The increase of the bearing noise indicates a fan fault. If the inverter is applied in a key position, replace the fan once the fan starts to generate unusual noise. You can purchase spare parts of fans from HITACHI.

Cooling fan replacement

	<p>◇ Read chapter 1 "Safety precautions" carefully and follow the instructions to perform operations. Otherwise, physical injuries or damage to the device may be caused.</p>
---	---

1. Stop the device, disconnect the AC power supply, and wait for a time no shorter than the waiting time designated on the inverter.
2. Open the cable clamp to loose the fan cable.
3. Remove the fan cable.
4. Remove the fan with a screwdriver.
5. Install a new fan in the inverter in the reverse steps. Assemble the inverter. Ensure that the air direction of the fan is consistent with that of the inverter, as shown in the following figure.

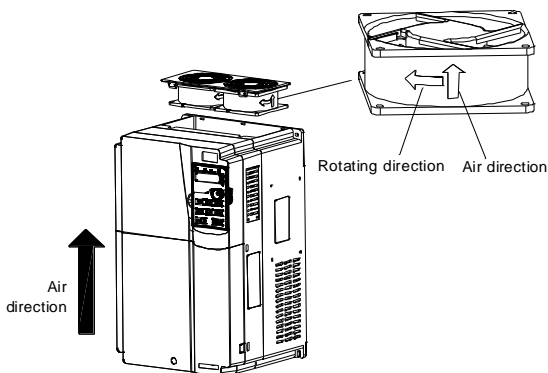

Fig 8.1 Fan maintenance for inverters of 7.5 kW or higher

6. Power on the inverter.

## 8.4 Capacitor

### 8.4.1 Capacitor reforming

If the inverter has been left unused for a long time, you need to follow the instructions to reform the DC bus capacitor before using it. The storage time is calculated from the date the inverter is delivered.

Storage time	Operation principle
Less than 1 year	No charging operation is required.
1 to 2 years	The inverter needs to be powered on for 1 hour before the first running command.
2 to 3 years	Use a voltage controlled power supply to charge the inverter: Charge the inverter at 25% of the rated voltage for 30 minutes, and then charge it at 50% of the rated voltage for 30 minutes, at 75% for another 30 minutes, and finally charge it at 100% of the rated voltage

Storage time	Operation principle
	for 30 minutes.
More than 3 years	Use a voltage controlled power supply to charge the inverter: Charge the inverter at 25% of the rated voltage for 2 hours, and then charge it at 50% of the rated voltage for 2 hours, at 75% for another 2 hours, and finally charge it at 100% of the rated voltage for 2 hours.

The method for using a voltage controlled power supply to charge the inverter is described as follows:

The selection of a voltage controlled power supply depends on the power supply of the inverter. For inverters with an incoming voltage of 1PH/3PH 230 V AC, you can use a 230 V AC/2 A voltage regulator. Both 1PH and 3PH inverters can be charged with a 1PH voltage controlled power supply (connect L+ to R, and N to S or T). All the DC bus capacitors share one rectifier, and therefore they are all charged.

For inverters of a high voltage class, ensure that the voltage requirement (for example, 400 V) is met during charging. Capacitor charging requires little current, and therefore you can use a small-capacity power supply (2 A is sufficient).

The method for using a resistor (incandescent lamp) to charge the drive is described as follows:

If you directly connect the drive device to a power supply to charge the DC bus capacitor, it needs to be charged for a minimum of 60 minutes. The charging operation must be performed at a normal indoor temperature without load, and you must connect a resistor in series mode in the 3PH circuit of the power supply.

For a 400 V drive device, use a resistor of 1 kΩ/100W. If the voltage of the power supply is no higher than 400 V, you can also use an incandescent lamp of 100W. If an incandescent lamp is used, it may go off or the light may become very weak.

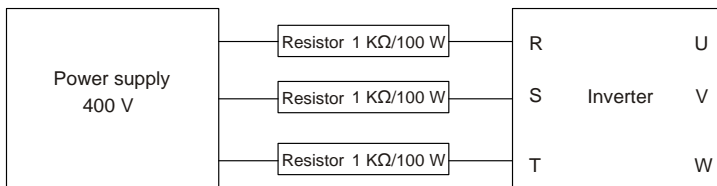



Fig 8.2 Charging circuit example of driving devices of 400 V

### 8.4.2 Electrolytic capacitor replacement

	<p>⚠ Read the safety precautions carefully and follow the instructions to perform operations. Otherwise, physical injuries or damage to the device may be caused.</p>
---	---

The electrolytic capacitor of an inverter must be replaced if it has been used for more than 35,000 hours. For details about the replacement, contact the local HITACHI office.

## 8.5 Power cable



◇ Read the safety precautions carefully and follow the instructions to perform operations. Otherwise, physical injuries or damage to the device may be caused.

1. Stop the inverter, disconnect the power supply, and wait for a time no shorter than the waiting time designated on the inverter.
2. Check the connection of the power cables. Ensure that they are firmly connected.
3. Power on the inverter.

## Chapter 9 Communication protocol

### 9.1 What this chapter contains

This chapter describes the communication protocol of S1 series products.

S1 series inverters provide RS485 communication interfaces and adopt the master-slave communication based on the international standard Modbus communication protocol. You can implement centralized control (setting commands for controlling the inverter, modifying the running frequency and related function code parameters, and monitoring the working state and fault information of the inverter) through PC/PLC, upper control computer, or other devices to meet specific application requirements.

### 9.2 Modbus protocol introduction

Modbus is a software protocol, a common language used in electronic controllers. By using this protocol, a controller can communicate with other devices through transmission lines. It is a general industrial standard. With this standard, control devices produced by different manufacturers can be connected to form an industrial network and be monitored in a centralized way.

A Modbus network is a control network with one master and multiple slaves, that is, on one Modbus network, there is only one device serving as the master, and other devices are the slaves. The master can communicate with one slave or broadcast messages to all the slaves. For separate access commands, a slave needs to return a response. For broadcasted information, slaves do not need to return responses.

### 9.3 Application of Modbus

S1 series inverters use the RTU mode provided by the Modbus protocol, and RS485 interfaces are used.

#### 9.3.1 RS485

RS485 interfaces work in half-duplex mode and transmit data signals in the differential transmission way, which is also referred to as balanced transmission. An RS485 interface uses a twisted pair, where one wire is defined as A (+), and the other B (-). Generally, if the positive electrical level between the transmission drives A and B ranges from +2 V to +6 V, the logic is "1"; and if it ranges from -2 V to -6 V, the logic is "0".

The 485+ terminal on the terminal block of the inverter corresponds to A, and 485- corresponds to B.

The communication baud rate (P14.01) indicates the number of bits transmitted in a second, and the unit is bit/s (bps). A higher baud rate indicates faster transmission and poorer anti-interference capability. When a twisted pair of 0.56 mm (24 AWG) is used, the maximum transmission distance varies according to the baud rate, as described in the following table.

Baud rate (bps)	Max. transmission distance	Baud rate (bps)	Max. transmission distance
2400	1800 m	9600	800 m
4800	1200 m	19200	600 m

When RS485 interfaces are used for long-distance communication, it is recommended that you use shielded cables, and use the shield layer as the ground wires.

When there are fewer devices and the transmission distance is short, the whole network works well without terminal load resistors. The performance, however, degrades as the distance increases. Therefore, it is recommended that you use a 120 Ω terminal resistor when the transmission distance is long.

**9.3.1.1 Application to one inverter**

Fig 9.1 is the Modbus wiring diagram of one inverter and a PC. Generally, PCs do not provide RS485 interfaces, so you need to convert an RS232 interface or USB port of a PC to an RS485 interface. Connect end A of the RS485 interface to the 485+ port on the terminal block of the inverter, and connect end B to the 485- port. It is recommended that you use shielded twisted pairs. When an RS232-RS485 converter is used, the cable used to connect the RS232 interface of the PC and the converter cannot be longer than 15 m. Use a short cable when possible. It is recommended that you insert the converter directly into the PC. Similarly, when a USB-RS485 converter is used, use a short cable when possible.

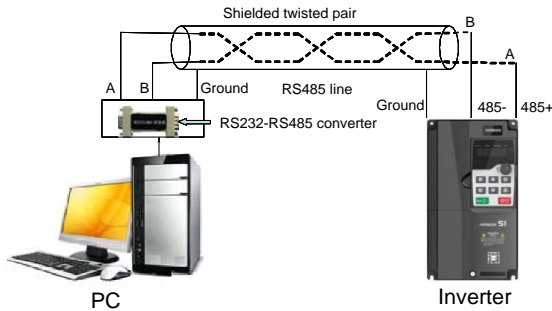

Fig 9.1 Wiring of RS485 applied to one inverter

**9.3.1.2 Application to multiple inverters**

In practical application to multiple inverters, daisy-chain connection and star connection are commonly used.

According to the requirements of the RS485 industrial bus standards, all the devices need to be connected in chrysanthemum mode with one 120 Ω terminal resistor on each end, as shown in Fig 9.2. Fig 9.3 is the simplified wiring diagram, and Fig 9.4 is the practical application diagram.

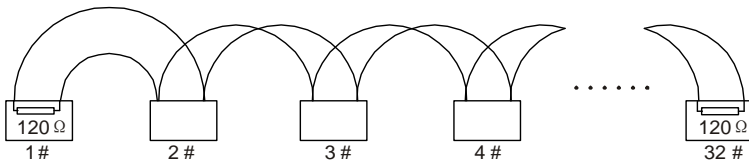

Fig 9.2 On-site daisy-chain connection diagram



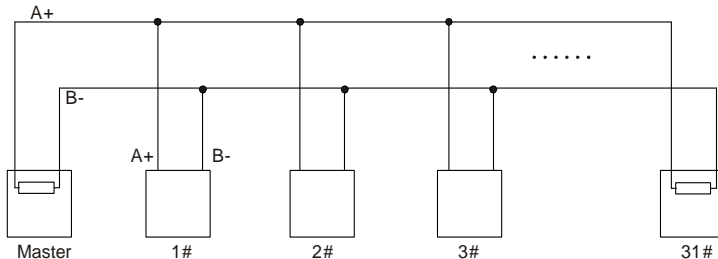

Fig 9.3 Simplified daisy-chain connection diagram

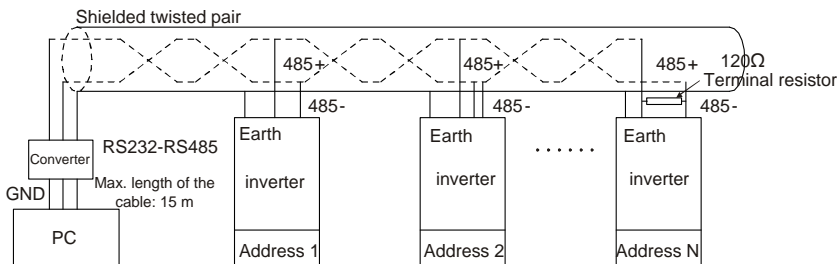

Fig 9.4 Practical application diagram of daisy-chain connection

Fig 9.5 shows the start connection diagram. When this connection mode is adopted, the two devices that are farthest away from each other on the line must be connected with a terminal resistor (in Fig 9.5, the two devices are devices 1# and 15#).

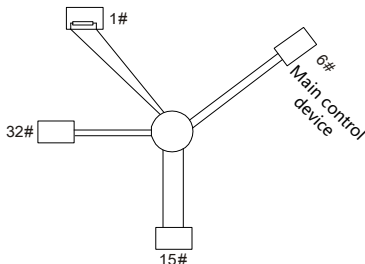

Fig 9.5 Star connection

Use shielded cable, if possible, in multi-device connection. The baud rates, data bit check settings, and other basic parameters of all the devices on the RS485 line must be set consistently, and addresses cannot be repeated.

**9.3.2 RTU mode**

**9.3.2.1 RTU communication frame structure**

When a controller is set to use the RTU communication mode on a Modbus network, every byte (8 bits) in the message includes 2 hexadecimal characters (each includes 4 bits). Compared with the ASCII mode, the RTU mode can transmit more data with the same baud rate.

**Code system**

- 1 start bit
- 7 or 8 data bits; the minimum valid bit is transmitted first. Each frame domain of 8 bits includes 2 hexadecimal characters (0–9, A–F).
- 1 odd/even check bit; this bit is not provided if no check is needed.
- 1 end bit (with check performed), 2 bits (without check)

**Error detection domain**

- Cyclic redundancy check (CRC)

The following table describes the data format.

11-bit character frame (Bits 1 to 8 are data bits)

Start bit	BIT1	BIT2	BIT3	BIT4	BIT5	BIT6	BIT7	BIT8	Check bit	End bit
-----------	------	------	------	------	------	------	------	------	-----------	---------

10-bit character frame (Bits 1 to 7 are data bits)

Start bit	BIT1	BIT2	BIT3	BIT4	BIT5	BIT6	BIT7	Check bit	End bit
-----------	------	------	------	------	------	------	------	-----------	---------

In a character frame, only the data bits carry information. The start bit, check bit, and end bit are used to facilitate the transmission of the data bits to the destination device. In practical applications, you must set the data bits, parity check bits, and end bits consistently.

In RTU mode, the transmission of a new frame always starts from an idle time (the transmission time of 3.5 bytes). On a network where the transmission rate is calculated based on the baud rate, the transmission time of 3.5 bytes can be easily obtained. After the idle time ends, the data domains are transmitted in the following sequence: slave address, operation command code, data, and CRC check character. Each byte transmitted in each domain includes 2 hexadecimal characters (0–9, A–F). The network devices always monitor the communication bus. After receiving the first domain (address information), each network device identifies the byte. After the last byte is transmitted, a similar transmission interval (the transmission time of 3.5 bytes) is used to indicate that the transmission of the frame ends. Then, the transmission of a new frame starts.

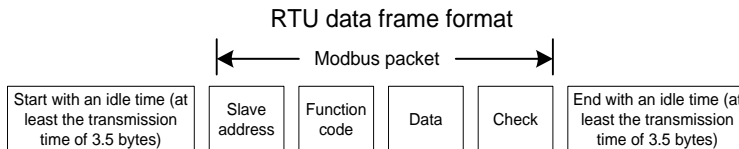

The information of a frame must be transmitted in a continuous data flow. If there is an interval greater than the transmission time of 1.5 bytes before the transmission of the entire frame is complete, the receiving device deletes the incomplete information, and mistakes the subsequent byte for the address domain of a new frame. Similarly, if the transmission interval between two frames is shorter than the transmission time of 3.5 bytes, the receiving device mistakes it for the data of the last frame.

The CRC check value is incorrect due to the disorder of the frames, and thus a communication fault occurs.

The following table describes the standard structure of an RTU frame.

START (frame header)	T1-T2-T3-T4 (transmission time of 3.5 bytes)
ADDR (slave address domain)	Communication address: 0–247 (decimal system) (0 is the broadcast address)
CMD (function domain)	03H: read slave parameters 06H: write slave parameters
DATA (N-1) ... DATA (0) (data domain)	Data of 2xN bytes, main content of the communication as well as the core of data exchanging
CRC CHK (LSBs)	Detection value: CRC (16 bits)
CRC CHK high bit (MSBs)	
END (frame tail)	T1-T2-T3-T4 (transmission time of 3.5 bytes)

**9.3.2.2 RTU communication frame error check modes**

During the transmission of data, errors may occur due to various factors. Without check, the data receiving device cannot identify data errors and may make a wrong response. The wrong response may cause severe problems. Therefore, the data must be checked.

The check is implemented as follows: The transmitter calculates the to-be-transmitted data based on a specific algorithm to obtain a result, adds the result to the rear of the message, and transmits them together. After receiving the message, the receiver calculates the data based on the same algorithm to obtain a result, and compares the result with that transmitted by the transmitter. If the results are the same, the message is correct. Otherwise, the message is considered wrong.

The error check of a frame includes two parts, namely, bit check on individual bytes (that is, odd/even check using the check bit in the character frame), and whole data check (CRC check).

**Bit check on individual bytes (odd/even check)**

You can select the bit check mode as required, or you can choose not to perform the check, which will affect the check bit setting of each byte.

Definition of even check: Before the data is transmitted, an even check bit is added to indicate whether the number of "1" in the to-be-transmitted data is odd or even. If it is even, the check bit is set to "0"; and if it is odd, the check bit is set to "1".

Definition of odd check: Before the data is transmitted, an odd check bit is added to indicate whether the number of "1" in the to-be-transmitted data is odd or even. If it is odd, the check bit is set to "0"; and if it is even, the check bit is set to "1".

For example, the data bits to be transmitted are "11001110", including five "1". If the even check is applied, the even check bit is set to "1"; and if the odd check is applied, the odd check bit is set to "0". During the transmission of the data, the odd/even check bit is calculated and placed in the check bit of the frame. The receiving device performs the odd/even check after receiving the data. If it finds that

the odd/even parity of the data is inconsistent with the preset information, it determines that a communication error occurs.

### **CRC check mode**

A frame in the RTU format includes an error detection domain based on the CRC calculation. The CRC domain checks all the content of the frame. The CRC domain consists of two bytes, including 16 binary bits. It is calculated by the transmitter and added to the frame. The receiver calculates the CRC of the received frame, and compares the result with the value in the received CRC domain. If the two CRC values are not equal to each other, errors occur in the transmission.

During CRC, 0xFFFF is stored first, and then a process is invoked to process a minimum of 6 contiguous bytes in the frame based on the content in the current register. CRC is valid only for the 8-bit data in each character. It is invalid for the start, end, and check bits.

During the generation of the CRC values, the "exclusive or" (XOR) operation is performed on the each 8-bit character and the content in the register. The result is placed in the bits from the least significant bit (LSB) to the most significant bit (MSB), and 0 is placed in the MSB. Then, LSB is detected. If LSB is 1, the XOR operation is performed on the current value in the register and the preset value. If LSB is 0, no operation is performed. This process is repeated 8 times. After the last bit (8<sup>th</sup> bit) is detected and processed, the XOR operation is performed on the next 8-bit byte and the current content in the register. The final values in the register are the CRC values obtained after operations are performed on all the bytes in the frame.

The calculation adopts the international standard CRC check rule. You can refer to the related standard CRC algorithm to compile the CRC calculation program as required.

The following is a simple CRC calculation function for your reference (using the C programming language):

```
unsigned int crc_cal_value(unsigned char*data_value,unsigned char data_length)
{
    int i;
    unsigned int crc_value=0xffff;
    while(data_length-->0)
    {
        crc_value^=*data_value++;
        for(i=0;i<8;i++)
        {
            if(crc_value&0x0001)
                crc_value=(crc_value>>1)^0xa001;
            else
                crc_value=crc_value>>1;
        }
    }
    return(crc_value);
}
```

In the ladder logic, CKSM uses the table look-up method to calculate the CRC value according to the

content in the frame. The program of this method is simple, and the calculation is fast, but the ROM space occupied is large. Use this program with caution in scenarios where there are space occupation limits on programs.

## 9.4 RTU command code and communication data

### 9.4.1 Command code: 03H, reading N words (continuously reading a maximum of 16 words)

The command code 03H is used by the master to read data from the inverter. The quantity of data to be read depends on the "data quantity" in the command. A maximum of 16 pieces of data can be read. The addresses of the read parameters must be contiguous. Each piece of data occupies 2 bytes, that is, one word. The command format is presented using the hexadecimal system (a number followed by "H" indicates a hexadecimal value). One hexadecimal value occupies one byte.

The 03H command is used to read information including the parameters and operation state of the inverter.

For example, starting from the data address of 0004H, to read two contiguous pieces of data (that is, to read content from the data addresses 0004H and 0005H), the structure of the frame is described in the following table.

RTU master command (transmitted by the master to the inverter)

START	T1-T2-T3-T4 (transmission time of 3.5 bytes)
ADDR (address)	01H
CMD (command code)	03H
Most significant byte (MSB) of the start address	00H
Least significant byte (LSB) of the start address	04H
MSB of data quantity	00H
LSB of data quantity	02H
LSB of CRC	85H
MSB of CRC	CAH
END	T1-T2-T3-T4 (transmission time of 3.5 bytes)

The value in START and END is "T1-T2-T3-T4 (transmission time of 3.5 bytes)", indicating that the RS485 needs to stay idle for at least the transmission time of 3.5 bytes. An idle time is required to distinguish on message from another to ensure that the two messages are not regarded as one.

The value of ADDR is 01H, indicating that the command is transmitted to the inverter whose address is 01H. The ADDR information occupies one byte.

The value of CMD is 03H, indicating that the command is used to read data from the inverter. The CMD information occupies one byte.

"Start address" indicates that data reading is started from this address. It occupies two bytes, with the MSB on the left and LSB on the right.

"Data quantity" indicates the quantity of data to be read (unit: word).

The value of "Start address" is 0004H, and that of "Data quantity" is 0002H, indicating that data is to be read from the data addresses of 0004H and 0005H.

CRC check occupies two bytes, with the LSB on the left, and MSB on the right.

RTU slave response (transmitted by the inverter to the master)

START	T1-T2-T3-T4 (transmission time of 3.5 bytes)
ADDR	01H
CMD	03H
Number of bytes	04H
MSB of data in 0004H	13H
LSB of data in 0004H	88H
MSB of data in 0005H	00H
LSB of data in 0005H	00H
LSB of CRC	7EH
MSB of CRC	9DH
END	T1-T2-T3-T4 (transmission time of 3.5 bytes)

The definition of the response information is described as follows:

The value of ADDR is 01H, indicating that the message is transmitted by the inverter whose address is 01H. The ADDR information occupies one byte.

The value of CMD is 03H, indicating that the message is a response of the inverter to the 03H command of the master for reading data. The CMD information occupies one byte.

"Number of bytes" indicates the number of bytes between a byte (not included) and the CRC byte (not included). The value 04 indicates that there are four bytes of data between "Number of bytes" and "LSB of CRC", that is, "MSB of data in 0004H", "LSB of data in 0004H", "MSB of data in 0005H", and "LSB of data in 0005H".

A piece of data is two bytes, with the MSB on the left and LSB on the right. From the response, we can see that the data in 0004H is 1388H, and that in 0005H is 0000H.

CRC check occupies two bytes, with the LSB on the left, and MSB on the right.

**9.4.2 Command code: 06H, writing a word**

This command is used by the master to write data to the inverter. One command can be used to write only one piece of data. It is used to modify the parameters and operation mode of the inverter.

For example, to write 5000 (1388H) to 0004H of the inverter whose address is 02H, the structure of the frame is described in the following table.

RTU master command (transmitted by the master to the inverter)

START	T1-T2-T3-T4 (transmission time of 3.5 bytes)
ADDR	02H
CMD	06H

S1 series standard inverter

MSB of data writing address	00H
LSB of data writing address	04H
MSB of to-be-written data	13H
LSB of to-be-written data	88H
LSB of CRC	C5H
MSB of CRC	6EH
END	T1-T2-T3-T4 (transmission time of 3.5 bytes)

RTU slave response (transmitted by the inverter to the master)

START	T1-T2-T3-T4 (transmission time of 3.5 bytes)
ADDR	02H
CMD	06H
MSB of data writing address	00H
LSB of data writing address	04H
MSB of to-be-written data	13H
LSB of to-be-written data	88H
LSB of CRC	C5H
MSB of CRC	6EH
END	T1-T2-T3-T4 (transmission time of 3.5 bytes)

**9.4.3 Command code: 08H, diagnosis**

Sub-function code description

Sub-function code	Description
0000	Return data based on query requests

For example, to query about the circuit detection information about the inverter whose address is 01H, the query and return strings are the same, and the format is described in the following tables.

RTU master command

START	T1-T2-T3-T4 (transmission time of 3.5 bytes)
ADDR	01H
CMD	08H
MSB of the sub-function code	00H
LSB of the sub-function code	00H
MSB of data	12H
LSB of data	ABH
LSB of CRC CHK	ADH
MSB of CRC CHK	14H
END	T1-T2-T3-T4 (transmission time of 3.5 bytes)

## RTU slave response

START	T1-T2-T3-T4 (transmission time of 3.5 bytes)
ADDR	01H
CMD	08H
MSB of the sub-function code	00H
LSB of the sub-function code	00H
MSB of data	12H
LSB of data	ABH
LSB of CRC CHK	ADH
MSB of CRC CHK	14H
END	T1-T2-T3-T4 (transmission time of 3.5 bytes)

**9.4.4 Command code: 10H, continuous writing**

The command code 10H is used by the master to write data to the inverter. The quantity of data to be written is determined by "Data quantity", and a maximum of 16 pieces of data can be written.

For example, to write 5000 (1388H) and 50 (0032H) respectively to 0004H and 0005H of the inverter whose slave address is 02H, the structure of the frame is described in the following table.

RTU master command (transmitted by the master to the inverter)

START	T1-T2-T3-T4 (transmission time of 3.5 bytes)
ADDR	02H
CMD	10H
MSB of data writing address	00H
LSB of data writing address	04H
MSB of data quantity	00H
LSB of data quantity	02H
Number of bytes	04H
MSB of data to be written to 0004H	13H
LSB of data to be written to 0004H	88H
MSB of data to be written to 0005H	00H
LSB of data to be written to 0005H	32H
LSB of CRC	C5H
MSB of CRC	6EH
END	T1-T2-T3-T4 (transmission time of 3.5 bytes)

RTU slave response (transmitted by the inverter to the master)

START	T1-T2-T3-T4 (transmission time of 3.5 bytes)
ADDR	02H
CMD	10H
MSB of data writing address	00H
LSB of data writing address	04H



MSB of data quantity	00H
LSB of data quantity	02H
LSB of CRC	C5H
MSB of CRC	6EH
END	T1-T2-T3-T4 (transmission time of 3.5 bytes)

#### 9.4.5 Data address definition

This section describes the address definition of communication data. The addresses are used for controlling the running, obtaining the state information, and setting related function parameters of the inverter.

##### 9.4.5.1 Function code address representation rules

The address of a function code consists of two bytes, with the MSB on the left and LSB on the right. The MSB ranges from 00 to ffH, and the LSB also ranges from 00 to ffH. The MSB is the hexadecimal form of the group number before the dot mark, and LSB is that of the number behind the dot mark. Take P05.06 as an example, the group number is 05, that is, the MSB of the parameter address is the hexadecimal form of 05; and the number behind the dot mark is 06, that is, the LSB is the hexadecimal form of 06. Therefore, the function code address is 0506H in the hexadecimal form. For P10.01, the parameter address is 0A01H.

#### Note:

1. The parameters in the P29 group are set by the manufacturer. They cannot be read or modified. Some parameters cannot be modified when the inverter is running; some cannot be modified regardless of the state of the inverter. Pay attention to the setting range, unit, and related description of a parameter when modifying it.
2. The service life of the Electrically Erasable Programmable Read-Only Memory (EEPROM) may be reduced if it is frequently used for storage. For users, some function codes do not need to be stored during communication. The application requirements can be met by modifying the value of the on-chip RAM, that is, modifying the MSB of the corresponding function code address from 0 to 1. For example, if P00.07 is not to be stored in the EEPROM, you need only to modify the value of the RAM, that is, set the address to 8007H. The address can be used only for writing data to the on-chip RAM, and it is invalid when used for reading data.

##### 9.4.5.2 Description of other function code addresses

In addition to modifying the parameters of the inverter, the master can also control the inverter, such as start and stop it, and monitor the operation state of the inverter. The following table describes other function parameters.

Function	Address	Data description	R/W
Communication-based control command	2000H	0001H: Forward running	R/W
		0002H: Reverse running	
		0003H: Forward jogging	
		0004H: Reverse jogging	
		0005H: Stop	

Function	Address	Data description	R/W
		0006H: Coast to stop (emergency stop)	
		0007H: Fault reset	
		0008H: Jogging to stop	
Communication-based value setting	2001H	Communication-based frequency setting (0–Fmax, unit: 0.01 Hz)	R/W
	2002H	PID setting, range (0–1000, 1000 corresponding to 100.0%)	
	2003H	PID feedback, range (0–1000, 1000 corresponding to 100.0%)	R/W
	2004H	Torque setting (-3000–+3000, 1000 corresponding to 100.0% of the rated current of the motor)	R/W
	2005H	Setting of the upper limit of the forward running frequency (0–Fmax, unit: 0.01 Hz)	R/W
	2006H	Setting of the upper limit of the reverse running frequency (0–Fmax, unit: 0.01 Hz)	R/W
	2007H	Upper limit of the electromotion torque (0–3000, 1000 corresponding to 100.0% of the rated current of the inverter)	R/W
	2008H	Upper limit of the brake torque (0–3000, 1000 corresponding to 100.0% of the rated current of the motor)	R/W
	2009H	Special control command word: Bit1–0 =00: Motor 1 =01: Motor 2 =10: Motor 3 =11: Motor 4 Bit2: =1 Torque control disabled =0: Torque control cannot be disabled Bit3: =1 Power consumption reset to 0 =0: Power consumption not reset Bit4: =1 Pre-excitation =0: Pre-excitation disabled Bit5: =1 DC brake =0: DC brake disabled	R/W
	200AH	Virtual input terminal command, range: 0x000–0x1FF	R/W
	200BH	Virtual output terminal command, range: 0x00–0x0F	R/W
200CH	Voltage setting (used when V/F separation is implemented) (0–1000, 1000 corresponding to 100.0% of the	R/W	

S1 series standard inverter

Function	Address	Data description	R/W
		rated voltage of the motor)	
	200DH	AO output setting 1 (-1000~+1000, 1000 corresponding to 100.0%)	R/W
	200EH	AO output setting 2 (-1000~+1000, 1000 corresponding to 100.0%)	R/W
Inverter state word 1	2100H	0001H: Forward running	R
		0002H: Reverse running	
		0003H: Stopped	
		0004H: Faulty	
		0005H: POFF	
		0006H: Pre-excited	
Inverter state word 2	2101H	Bit0: =0: Not ready to run =1: Ready to run Bit2-1: =00: Motor 1 =01: Motor 2 =10: Motor 3 =11: Motor 4 Bit3: =0: Asynchronous machine Bit4: =0: No overload alarm =1: Overload alarm Bit6-5: =00: Keypad-based control =01: Terminal-based control =10: Communication-based control Bit7: Reserved Bit8: =0: Speed control =1: Torque control Bit9: =0: Non-position control =1: Position control Bit11-10: =0: Vector 0 =1: Vector 1 =2: Closed-loop vector =3: Space voltage vector	R
Inverter fault code	2102H	See the description of fault types.	R
Running frequency	3000H	0~Fmax (unit: 0.01Hz)	R
Set frequency	3001H	0~Fmax (unit: 0.01Hz)	R
Bus voltage	3002H	0.0~2000.0 V (unit: 0.1V)	R
Output voltage	3003H	0~1200V (unit: 1V)	R
Output current	3004H	0.0~3000.0A (unit: 0.1A)	R
Rotating speed	3005H	0~65535 (unit: 1RPM)	R
Output power	3006H	-300.0~+300.0% (unit: 0.1%)	R
Output torque	3007H	-250.0~+250.0% (unit: 0.1%)	R
Closed-loop setting	3008H	-100.0~+100.0% (unit: 0.1%)	R
Closed-loop feedback	3009H	-100.0~+100.0% (unit: 0.1%)	R
Input state	300AH	000~1FF	R
Output state	300BH	000~1FF	R
Analog input 1	300CH	0.00~10.00V (unit: 0.01V)	R

Function	Address	Data description	R/W
Analog input 2	300DH	0.00–10.00V (unit: 0.01V)	R
Analog input 3	300EH	-10.00–10.00V (unit: 0.01V)	R
Read input of high-speed pulse 1	3010H	0.00–50.00kHz (unit: 0.01Hz)	R
Read current step of multi-step speed	3012H	0–15	R
External length	3013H	0–65535	R
External count value	3014H	0–65535	R
Torque setting	3015H	-300.0–+300.0% (unit: 0.1%)	R

The Read/Write (R/W) characteristics indicate whether a function can be read and written. For example, "Communication-based control command" can be written, and therefore the command code 6H is used to control the inverter. The R characteristic indicates that a function can only be read, and W indicates that a function can only be written.

**Note:** Some parameters in the preceding table are valid only after they are enabled. Take the running and stop operations as examples, you need to set "Running command channel" (P00.01) to "Communication". For another example, when modifying "PID setting", you need to set "PID reference source" (P09.00) to Modbus communication.

#### 9.4.6 Fieldbus scale

In practical applications, communication data is represented in the hexadecimal form, but hexadecimal values cannot represent decimals. For example, 50.12 Hz cannot be represented in the hexadecimal form. In such cases, we can multiply 50.12 by 100 to obtain an integer 5012, and then 50.12 can be represented as 1394H (5012 in the decimal form) in the hexadecimal form.

In the process of multiplying a non-integer by a multiple to obtain an integer, the multiple is referred to as a fieldbus scale.

The fieldbus scale depends on the number of decimals in the value specified in "Detailed parameter description" or "Default value". If there are  $n$  decimals in the value, the fieldbus scale  $m$  is the  $n^{\text{th}}$ -power of 10. Take the following table as an example,  $m$  is 10.

Function code	Name	Detailed parameter description	Default value
P01.20	Wake-up-from-sleep delay	0.0–3600.0s (valid when P01.19 is 2)	0.0s
P01.21	Restart after power down	0: Restart is disabled 1: Restart is enabled	0

The value specified in "Detailed parameter description" or "Default value" contains one decimal, so the fieldbus scale is 10. If the value received by the upper computer is 50, the value of "Wake-up-from-sleep delay" of the inverter is 5.0 ( $5.0=50/10$ ).

To set the "Wake-up-from-sleep delay" to 5.0s through Modbus communication, you need first to multiply 5.0 by 10 according to the scale to obtain an integer 50, that is, 32H in the hexadecimal form, and then transmit the following write command:

01
06
01 14
00 32
49 E7

Inverter address
Write command
Parameter address
Parameter data
CRC

After receiving the command, the inverter converts 50 into 5.0 based on the fieldbus scale, and then sets "Wake-up-from-sleep delay" to 5.0s.

For another example, after the upper computer transmits the "Wake-up-from-sleep delay" parameter read command, the master receives the following response from the inverter:

01
03
02
00 32
39 91

Inverter address
Read command
2-byte data
Parameter data
CRC

The parameter data is 0032H, that is, 50, so 5.0 is obtained based on the fieldbus scale (50/10=5.0). In this case, the master identifies that the "Wake-up-from-sleep delay" is 5.0s.

#### 9.4.7 Error message response

Operation errors may occur in communication-based control. For example, some parameters can only be read, but a write command is transmitted. In this case, the inverter returns an error message response.

Error message responses are transmitted by the inverter to the master. The following table describes the codes and definitions of the error message responses.

Code	Name	Definition
01H	Invalid command	The command code received by the upper computer is not allowed to be executed. The possible causes are as follows: <ul style="list-style-type: none"> <li>• The function code is applicable only on new devices and is not implemented on this device.</li> <li>• The slave is in the faulty state when processing this request.</li> </ul>
02H	Invalid data address	For the inverter, the data address in the request of the upper computer is not allowed. In particular, the combination of the register address and the number of the to-be-transmitted bytes is invalid.
03H	Invalid data bit	The received data domain contains a value that is not allowed. The value indicates the error of the remaining structure in the combined request. <p><b>Note:</b> It does not mean that the data item submitted for storage in the register includes a value unexpected by the program.</p>
04H	Operation failure	The parameter is set to an invalid value in the write operation. For example, a function input terminal cannot be set repeatedly.
05H	Password	The password entered in the password verification address is

S1 series standard inverter

Code	Name	Definition
	error	different from that set in P07.00.
06H	Data frame error	The length of the data frame transmitted by the upper computer is incorrect, or in the RTU format, the value of the CRC check bit is inconsistent with the CRC value calculated by the lower computer
07H	Parameter read-only	The parameter to be modified in the write operation of the upper computer is a read-only parameter.
08H	Parameter cannot be modified in running	The parameter to be modified in the write operation of the upper computer cannot be modified during the running of the inverter.
09H	Password protection	A user password is set, and the upper computer does not provide the password to unlock the system when performing a read or write operation. The error of "system locked" is reported.

When returning a response, the device uses a function code domain and fault address to indicate whether it is a normal response (no error) or exception response (some errors occur). In a normal response, the device returns the corresponding function code and data address or sub-function code. In an exception response, the device returns a code that is equal to a normal code, but the first bit is logic 1.

For example, if the master device transmits a request message to a slave device for reading a group of function code address data, the code is generated as follows:

0 0 0 0 0 1 1 (03H in the hexadecimal form)

For a normal response, the same code is returned.

For an exception response, the following code is returned:

1 0 0 0 0 1 1 (83H in the hexadecimal form)

In addition to the modification of the code, the slave returns a byte of exception code that describes the cause of the exception. After receiving the exception response, the typical processing of the master device is to transmit the request message again or modify the command based on the fault information.

For example, to set the "Running command channel" (P00.01, the parameter address is 0001H) of the inverter whose address is 01H to 03, the command is as follows:

**01**  
Inverter  
address
**06**  
Write  
command
**00 01**  
Parameter  
address
**00 03**  
Parameter  
data
**98 0B**  
CRC

But the setting range of the "Running command channel" is 0 to 2. The value 3 exceeds the setting range. In this case, the inverter returns an error message response as shown in the following:

<b><u>01</u></b>	<b><u>86</u></b>	<b><u>04</u></b>	<b><u>43 A3</u></b>
Inverter address	Exception response code	Error code	CRC

The exception response code 86H (generated based on the MSB "1" of the write command 06H) indicates that it is an exception response to the write command (06H). The error code is 04H. From the preceding table, we can see that it indicates the error "Operation failure", which means "The parameter is set to an invalid value in the write operation".

**9.4.8 Read/Write operation example**

For the formats of the read and write commands, see sections 9.4.1 and 9.4.2.

**9.4.8.1 Read command 03H examples**

Example 1: Read state word 1 of the inverter whose address is 01H. From the table of other function parameters, we can see that the parameter address of state word 1 of the inverter is 2100H.

The read command transmitted to the inverter is as follows:

<b><u>01</u></b>	<b><u>03</u></b>	<b><u>21 00</u></b>	<b><u>00 01</u></b>	<b><u>8E 36</u></b>
Inverter address	Read command	Parameter address	Data quantity	CRC

Assume that the following response is returned:

<b><u>01</u></b>	<b><u>03</u></b>	<b><u>02</u></b>	<b><u>00 03</u></b>	<b><u>F8 45</u></b>
Inverter address	Read command	Number of bytes	Data content	CRC

The data content returned by the inverter is 0003H, which indicates that the inverter is in the stopped state.

Example 2: View information about the inverter whose address is 03H, including "Type of current fault" (P07.27) to "Type of last but four fault" (P07.32) of which the parameter addresses are 071BH to 0720H (contiguous 6 parameter addresses starting from 071BH).

The command transmitted to the inverter is as follows:

<b><u>03</u></b>	<b><u>03</u></b>	<b><u>07 1B</u></b>	<b><u>00 06</u></b>	<b><u>B5 59</u></b>
Inverter address	Read command	Start address	6 parameters in total	CRC

Assume that the following response is returned:

<b><u>03</u></b>	<b><u>03</u></b>	<b><u>0C</u></b>	<b><u>00 23</u></b>	<b><u>00 23</u></b>	<b><u>00 23</u></b>	<b><u>00 23</u></b>	<b><u>00 23</u></b>	<b><u>00 23</u></b>	<b><u>5F D2</u></b>
Inverter address	Read command	Number of bytes	Type of current fault	Type of last fault	Type of last but one fault	Type of last but two fault	Type of last but three fault	Type of last but four fault	CRC

From the returned data, we can see that all the fault types are 0023H, that is, 35 in the decimal form, which means the maladjustment fault (STo)

**9.4.8.2 Write command 06H examples**

Example 1: Set the inverter whose address is 03H to be forward running. Refer to the table of other function parameters, the address of "Communication-based control command" is 2000H, and 0001H indicates forward running, as shown in the following figure.

Function	Address	Data description	R/W
Communication-based control command	2000H	0001H: Forward running	R/W
		0002H: Reverse running	
		0003H: Forward jogging	
		0004H: Reverse jogging	
		0005H: Stop	
		0006H: Coast to stop (emergency stop)	
		0007H: Fault reset	
		0008H: Jogging to stop	

The command transmitted by the master is as follows:

**03**      **06**      **20 00**      **00 01**      **42 28**  
 Inverter address      Write command      Parameter address      Forward running      CRC

If the operation is successful, the following response is returned (same as the command transmitted by the master):

**03**      **06**      **20 00**      **00 01**      **42 28**  
 Inverter address      Write command      Parameter address      Forward running      CRC

Example 2: Set the "Max. output frequency" of the inverter whose address is 03H to 100 Hz.

Function code	Name	Detailed parameter description	Default value	Modify
P00.03	Max. output frequency	Used to set the maximum output frequency of the inverter. It is the basis of frequency setup and the acceleration/deceleration. Setting range: Max (P00.04, 10.00)–630.00Hz	50.00Hz	⊙

From the number of decimals, we can see that the fieldbus scale of the "Max. output frequency" (P00.03) is 100. Multiply 100 Hz by 100. The value 10000 is obtained, and it is 2710H in the hexadecimal form.

The command transmitted by the master is as follows:

**03**      **06**      **00 03**      **27 10**      **62 14**  
 Inverter address      Write command      Parameter address      Parameter data      CRC

If the operation is successful, the following response is returned (same as the command transmitted



by the master):

<b><u>03</u></b>	<b><u>06</u></b>	<b><u>00 03</u></b>	<b><u>27 10</u></b>	<b><u>62 14</u></b>
Inverter address	Write command	Parameter address	Parameter data	CRC

**Note:** In the preceding command description, spaces are added to a command just for explanatory purposes. In practical applications, no space is required in the commands.

#### 9.4.8.3 Continuously write command 10H examples

Example 1: Set the inverter whose address is 01H to be forward running at the frequency of 10 Hz. Refer to the table of other function parameters, the address of "Communication-based control command" is 2000H, 0001H indicates forward running, and the address of "Communication-based value setting" is 2001H, as shown in the following figure. 10 Hz is 03E8H in the hexadecimal form.

Function	Address	Data description	R/W
Communication-based control command	2000H	0001H: Forward running	R/W
		0002H: Reverse running	
		0003H: Forward jogging	
		0004H: Reverse jogging	
		0005H: Stop	
		0006H: Coast to stop (emergency stop)	
		0007H: Fault reset	
		0008H: Jogging to stop	
Communication-based value setting	2001H	Communication-based frequency setting (0–Fmax, unit: 0.01 Hz)	R/W
	2002H	PID setting, range (0–1000, 1000 corresponding to 100.0%)	

In the actual operation, set P00.01 to 2 and P00.06 to 8.

The command transmitted by the master is as follows:

<b><u>01</u></b>	<b><u>10</u></b>	<b><u>20 00</u></b>	<b><u>00 02</u></b>	<b><u>04</u></b>	<b><u>00 01</u></b>	<b><u>03 E8</u></b>	<b><u>3B 10</u></b>
Inverter address	Continuous write command	Parameter address	Parameter quantity	Number of bytes	Forward running	10 Hz	CRC

If the operation is successful, the following response is returned:

<b><u>01</u></b>	<b><u>10</u></b>	<b><u>20 00</u></b>	<b><u>00 02</u></b>	<b><u>4A 08</u></b>
Inverter address	Continuous write command	Parameter address	Parameter quantity	CRC

Example 2: Set "Acceleration time" of the inverter whose address is 01H to 10s, and "Deceleration time" to 20s.

S1 series standard inverter

Function code	Name	Detailed parameter description	Default value	Modify
P00.11	Acceleration time 1	Acceleration time is the time needed for accelerating from 0Hz to Max. output frequency (P00.03).	Depend on model	○
P00.12	Deceleration time 1	Deceleration time is the time needed from decelerating from Max. output frequency (P00.03) to 0Hz. S1 series inverter defines four groups of acceleration and deceleration time, which can be selected via multi-function digital input terminals (P05 group). The acceleration/deceleration time of the inverter is the first group by default. Setting range of P00.11 and P00.12: 0.0–3600.0s	Depend on model	○

The address of P00.11 is 000B, 10s is 0064H in the hexadecimal form, and 20s is 00C8H in the hexadecimal form.

The command transmitted by the master is as follows:

01    10    00 0B    00 02    04    00 64    00 C8    F2 55  
 Inverter    Continuous    Parameter    Parameter    Number of    10s    20s    CRC  
 address    write    address    quantity    bytes

If the operation is successful, the following response is returned:

01    10    00 0B    00 02    30 0A  
 Inverter    Continuous    Parameter    Parameter    CRC  
 address    write    address    quantity

**Note:** In the preceding command description, spaces are added to a command just for explanatory purposes. In practical applications, no space is required in the commands.

**9.4.8.4 Modbus communication commissioning example**

A PC is used as the host, an RS232-RS485 converter is used for signal conversion, and the PC serial port used by the converter is COM1 (an RS232 port). The upper computer commissioning software is the serial port commissioning assistant Commix, which can be downloaded from the Internet. Download a version that can automatically execute the CRC check function. The following figure shows the interface of Commix.

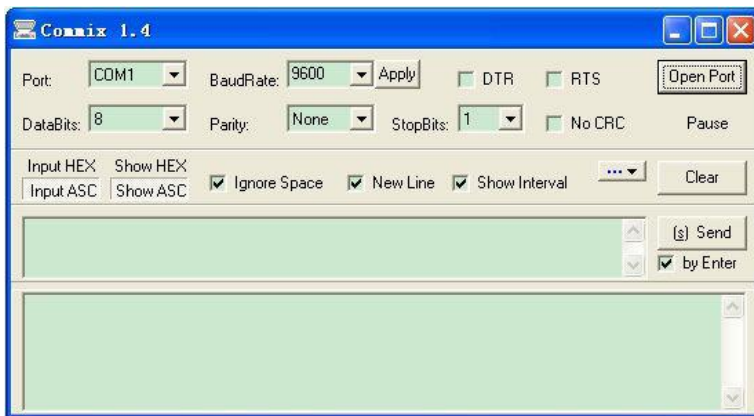

First, set the serial port to **COM1**. Then, set the baud rate consistently with P14.01. The data bits, check bits, and end bits must be set consistently with P14.02. If the RTU mode is selected, you need to select the hexadecimal form **Input HEX**. To set the software to automatically execute the CRC function, you need to select **ModbusRTU**, select **CRC16 (MODBU SRTU)**, and set the start byte to 1. After the auto CRC check function is enabled, do not enter CRC information in commands. Otherwise, command errors may occur due to repeated CRC check.

The commissioning command to set the inverter whose address is 03H to be forward running is as follows:

<b><u>03</u></b>	<b><u>06</u></b>	<b><u>20 00</u></b>	<b><u>00 01</u></b>	<b><u>42 28</u></b>	
Inverter address	Write command	Parameter address	Forward running	CRC	

**Note:**

1. Set the address (P14.00) of the inverter to 03.
2. Set "Channel of running commands" (P00.01) to "Communication", and set "Communication channel of running commands" (P00.02) to the Modbus communication channel.
3. Click **Send**. If the line configuration and settings are correct, a response transmitted by the inverter is received as follows:

<b><u>03</u></b>	<b><u>06</u></b>	<b><u>20 00</u></b>	<b><u>00 01</u></b>	<b><u>42 28</u></b>	
Inverter address	Write command	Parameter address	Forward running	CRC	

## **9.5 Common communication faults**

Common communication faults include the following:

- No response is returned.
- The inverter returns an exception response.

Possible causes of no response include the following:

- The serial port is set incorrectly. For example, the converter uses the serial port COM1, but COM2 is selected for the communication.
- The settings of the baud rates, data bits, end bits, and check bits are inconsistent with those set on the inverter.
- The positive pole (+) and negative pole (-) of the RS485 bus are connected reversely.
- The resistor connected to 485 terminals on the terminal block of the inverter is set incorrectl

## Chapter 10 Technical data

### 10.1 What this chapter contains

This chapter describes the technical data of the inverter and its compliance to CE and other quality certification systems.

### 10.2 Derated application

#### 10.2.1 Capacity

Choose an inverter based on the rated current and power of the motor. To endure the rated power of the motor, the rated output current of the inverter must be larger or equal to the rated current of the motor. The rated power of the inverter must be higher or equal to that of the motor.

#### Note:

1. The maximum allowable shaft power of the motor is limited to 1.5 times the rated power of the motor. If the limit is exceeded, the inverter automatically restricts the torque and current of the motor. This function effectively protects the input shaft against overload.
2. The rated capacity is the capacity at the ambient temperature of 40°C.
3. You need to check and ensure that the power flowing through the common DC connection in the common DC system does not exceed the rated power of the motor.

#### 10.2.2 Derating

If the ambient temperature on the site where the inverter is installed exceeds 40°C, the altitude exceeds 1000 m, or the switching frequency is changed from 4 kHz to 8, 12, or 15 kHz, the inverter needs to be derated.

##### 10.2.2.1 Derating due to temperature

When the temperature ranges from +40°C to +50°C, the rated output current is derated by 1% for each increased 1°C. For the actual derating, see the following figure.

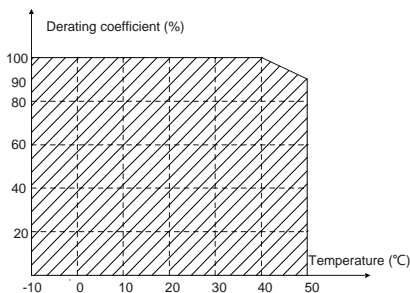

**Note:** It is not recommended to use the inverter at a temperature higher than 50°C. If you do, you shall be held accountable for the consequences caused.

##### 10.2.2.2 Derating due to altitude

When the altitude of the site where the inverter is installed is lower than 1000 m, the inverter can run at the rated power. If the altitude is higher than 1000 m, the allowable output power is derated. For details about the derating, see the following figure.

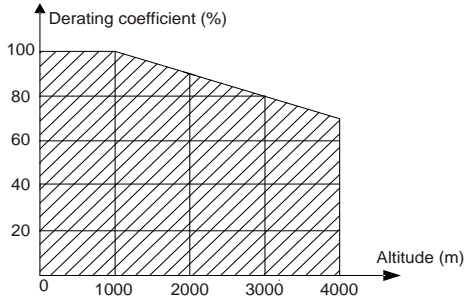

### 10.2.2.3 Derating due to carrier frequency

The power of S1 series inverters varies according to carrier frequencies. The rated power of an inverter is defined based on the carrier frequency set in factory. If the carrier frequency exceeds the factory setting, the power of the inverter is derated by 10% for each increased 1 kHz.

## 10.3 Grid specifications

<b>Grid voltage</b>	AC 1PH 220V (-15%)–240V (+10%) AC 3PH 380V (-15%)–440V (+10%)
<b>Short-circuit capacity</b>	According to the definition of IEC 60439-1, the 0.4–15kW inverters are suitable for the use on the grid with the maximum expected short-circuit current no more than 5kA at the maximum rated voltage; the 18.5–110kW inverters are suitable for the use on the grid with the maximum expected short-circuit current no more than 22kA at the maximum rated voltage; the 132–400kW inverters are suitable for the use on the grid with maximum expected short-circuit current no more than 100kA at the maximum rated voltage.
<b>Frequency</b>	50/60 Hz±5%, with a maximum change rate of 20%/s

## 10.4 Motor connection data

<b>Motor type</b>	Asynchronous induction motor
<b>Voltage</b>	0–U1 (rated voltage of the motor), 3PH symmetrical, Umax (rated voltage of the inverter) at the field-weakening point
<b>Short-circuit protection</b>	The short-circuit protection for the motor output meets the requirements of IEC 61800-5-1.
<b>Frequency</b>	0–400 Hz
<b>Frequency resolution</b>	0.01 Hz
<b>Current</b>	See the rated current.
<b>Power limit</b>	1.5 times of the rated power of the motor
<b>Field-weakening point</b>	10–400 Hz
<b>Carrier frequency</b>	4, 8, 12, or 15 kHz

### 10.4.1 EMC compatibility and motor cable length

The following table describes the maximum motor cable lengths that meet the requirements of the EU EMC directive (2014/30/EU).

All models (with external EMC filters)	Maximum motor cable length (m)
Environment category II (C3)	30

You can learn the maximum length of the motor cable through the running parameters of the inverter. To understand the accurate maximum cable length for using an external EMC filter, contact the local HITACHI office.

For description about the environments categories I (C2) and II (C3), see section "EMC regulations".

### 10.5 Application standards

The following table describes the standards that the inverters comply with.

EN/ISO 13849-1	Safety of machinery—Safety-related parts of control systems—Part 1: General principles for design
IEC/EN 60204-1	Safety of machinery—Electrical equipment of machines. Part 1: General requirements
IEC/EN 62061	Safety of machinery—Safety-related functional safety of electrical, electronic, and programmable electronic control systems
IEC/EN 61800-3+A1	Adjustable speed electrical power drive systems—Part 3: EMC requirements and specific test methods
IEC/EN 61800-5-1+A1	Adjustable speed electrical power drive systems—Part 5-1: Safety requirements—Electrical, thermal and energy
IEC/EN 61800-5-2+A1	Adjustable speed electrical power drive systems—Part 5-2: Safety requirements—Function

#### 10.5.1 CE marking

The CE marking on the name plate of an inverter indicates that the inverter is CE-compliant, meeting the regulations of the European low-voltage directive (2014/35/EU) and EMC directive (2014/30/EU).

#### 10.5.2 EMC compliance declaration

European union (EU) stipulates that the electric and electrical devices sold in Europe cannot generate electromagnetic disturbance that exceeds the limits stipulated in related standards, and can work properly in environments with certain electromagnetic interference. The EMC product standard (EN 61800-3) describes the EMC standards and specific test methods for adjustable speed electrical power drive systems. Products must strictly follow these EMC regulations.

### 10.6 EMC regulations

The EMC product standard (EN 61800-3) describes the EMC requirements on inverters.

Application environment categories

Category I: Civilian environments, including application scenarios where inverters are directly connected to the civil power supply low-voltage grids without intermediate transformers

Category II: All environments except those in Category I.

Inverter categories

C1: Rated voltage lower than 1000 V, applied to environments of Category I.

C2: Rated voltage lower than 1000 V, non-plug, socket, or mobile devices; power drive systems that must be installed and operated by specialized personnel when applied to environments of Category I

**Note:** The EMC standard IEC/EN 61800-3 no longer restricts the power distribution of inverters, but it specifies their use, installation, and commissioning. Specialized personnel or organizations must have the necessary skills (including the EMC-related knowledge) for installing and/or performing commissioning on the electrical drive systems.

C3: Rated voltage lower than 1000 V, applied to environments of Category II. They cannot be applied to environments of Category I.

C4: Rated voltage higher than 1000 V, or rated current higher or equal to 400 A, applied to complex systems in environments of Category II.

**10.6.1 Inverter category of C2**

The induction disturbance limit meets the following stipulations:

1. Select an optional EMC filter according to Chapter 12 and install it following the description in the EMC filter manual.
2. Select the motor and control cables according to the description in the manual.
3. Install the inverter according to the description in the manual.
4. For the maximum length of the motor cable, see section "EMC compatibility and motor cable length".

	◇ Currently in environments in China, the inverter may generate radio interference, you need to take measures to reduce the interference.
---	---

**10.6.2 Inverter category of C3**

The anti-interference performance of the inverter meets the requirements of environments Category II in the IEC/EN 61800-3 standard.

The induction disturbance limit meets the following stipulations:

1. Select an optional EMC filter according to Chapter 12 and install it following the description in the EMC filter manual.
2. Select the motor and control cables according to the description in the manual.
3. Install the inverter according to the description in the manual.
4. For the maximum length of the motor cable, see section "EMC compatibility and motor cable length".

	◇ Inverters of C3 category cannot be applied to civilian low-voltage common grids. When applied to such grids, the inverter may generate radio frequency electromagnetic interference.
---	--



## Chapter 11 Dimension drawings

### 11.1 What this chapter contains

This chapter describes the dimension drawings of S1 series inverters. The dimension unit used in the drawings is mm.

### 11.2 400V Keypad structure

#### 11.2.1 Structure diagram

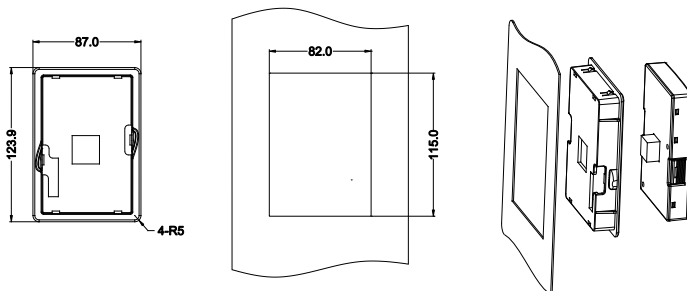
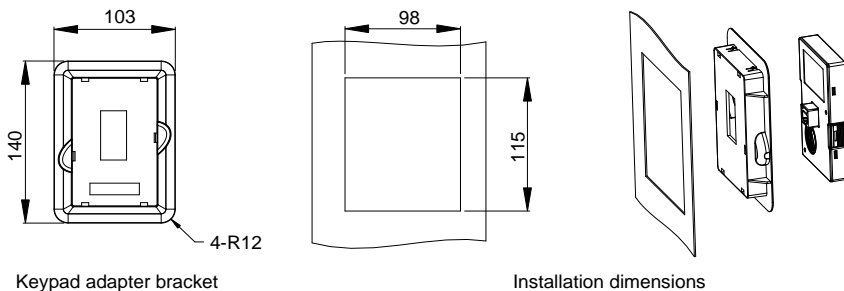

Fig 11.1 Keypad structure diagram

#### 11.2.2 Keypad installation bracket

**Note:** When installing an external keypad, you can directly use threaded screws or a keypad bracket. For inverters of 400 V, 4 to 75 kW, you need to use optional keypad installation brackets. For those of 400 V, 90 to 400 kW, you can use optional brackets or use the standard keypad brackets externally.



Keypad adapter bracket

Installation dimensions

Fig 11.2 Keypad structure for inverters 400 V, 4 to 400 kW

### 11.3 Inverter structure

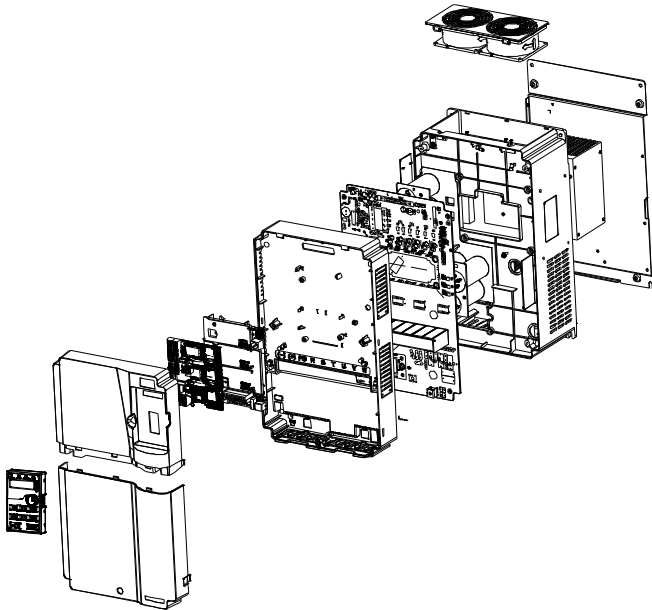

Fig 11.3 Inverter structure diagram

### 11.4 Dimensions of Inverters

#### 11.4.1 Rail-mounting dimensions

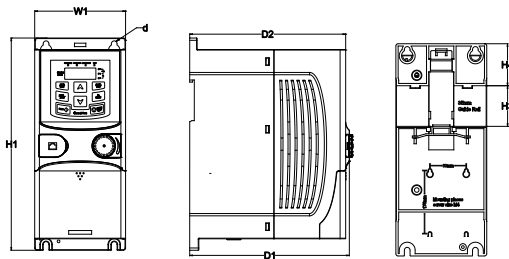

Fig 11.4 Rail-mounting diagram of inverters 230V/400 V, up to 2.2 kW

Model	W1	H1	H3	H4	D1	D2	Installation hole diameter
0.4kW -0.75kW, 230V	80.0	160.0	35.4	36.6	123.5	120.3	5
1.5kW -2.2kW, 230V	80.0	185.0	35.4	36.6	140.5	137.3	5
0.75kW -2.2kW, 400V	80.0	185.0	35.4	36.6	140.5	137.3	5

11.4.2 Wall-mounting dimensions

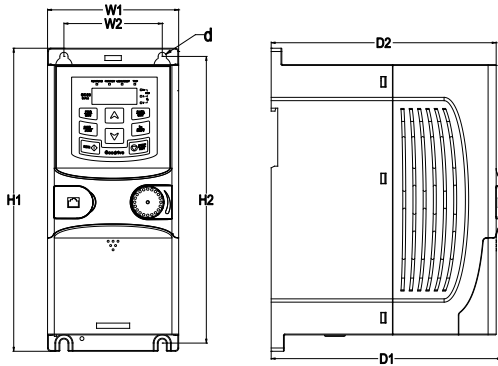

Fig 11.5 Wall-mounting diagram of inverters 230V/400 V, up to 2.2 kW

Model	W1	W2	H1	H2	D1	D2	Installation hole diameter
0.4kW -0.75kW, 230V	80.0	60.0	160.0	150.0	123.5	120.3	5
1.5kW -2.2kW, 230V	80.0	60.0	185.0	175.0	140.5	137.3	5
0.75kW -2.2kW, 400V	80.0	60.0	185.0	175.0	140.5	137.3	5

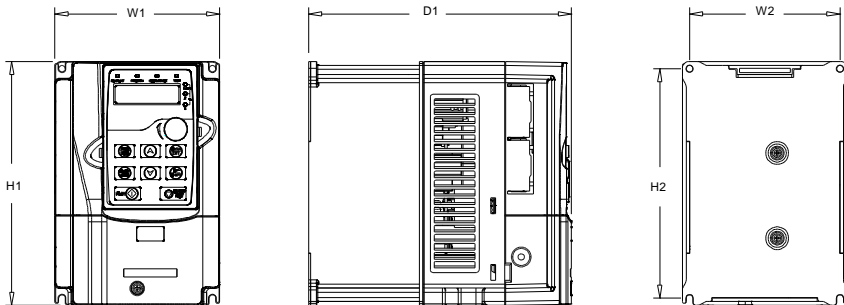

Fig 11.6 Wall-mounting diagram of inverters of 400 V, 4 to 37 kW

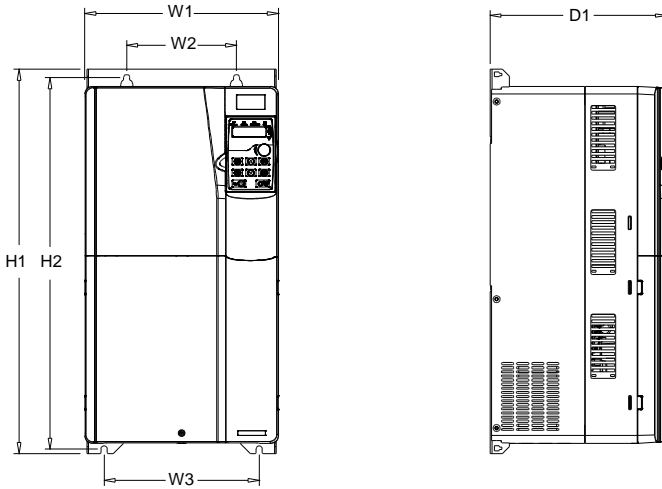

Fig 11.7 Wall-mounting diagram of inverters of 400 V, 45 to 75 kW

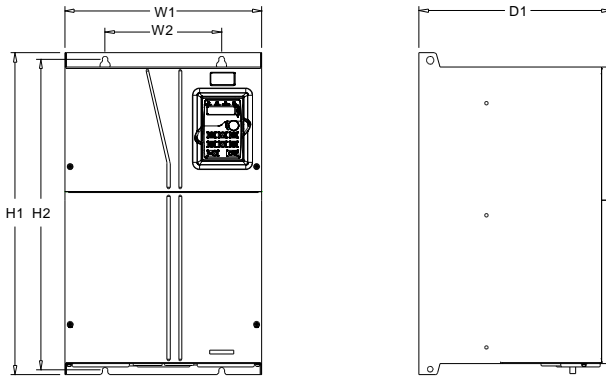

Fig 11.8 Wall-mounting diagram of inverters of 400 V, 90 to 110 kW

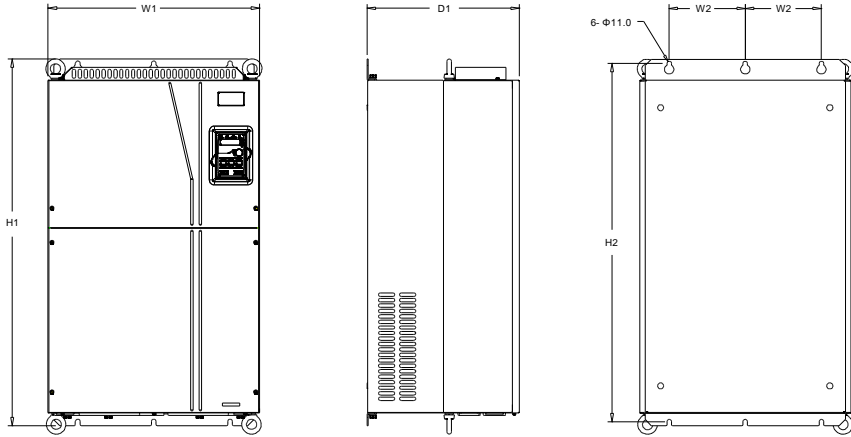

Fig 11.9 Wall-mounting diagram of inverters of 400 V, 132 to 200 kW

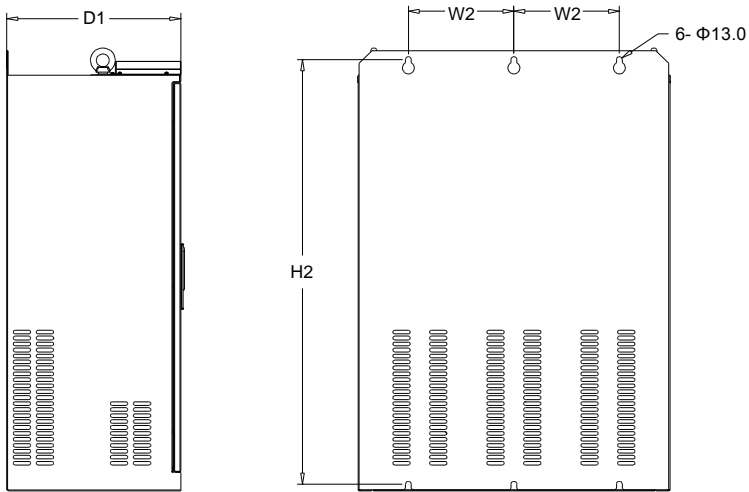

Fig 11.10 Wall-mounting diagram of inverters of 400 V, 220 to 315 kW

Wall-mounting dimensions of 400 V inverters (unit: mm)

Inverter specification	W1	W2	W3	H1	H2	D1	Installation hole diameter	Fixing screw
4kW -5.5kW	126	115	-	186	175	201	5	M4
7.5kW	146	131	-	256	243.5	192	6	M5

S1 series standard inverter

Inverter specification	W1	W2	W3	H1	H2	D1	Installation hole diameter	Fixing screw
11kW–15kW	170	151	-	320	303.5	220	6	M5
18.5kW–22kW	200	185	-	340.6	328.6	208	6	M5
30kW–37kW	250	230	-	400	380	223	6	M5
45kW–75kW	282	160	226	560	542	258	9	M8
90kW–110kW	338	200	-	554	535	330	10	M8
132kW–200kW	500	180	-	870	850	360	11	M10
220kW–315kW	680	230	-	960	926	380	13	M12

11.4.3 Flange installation dimensions

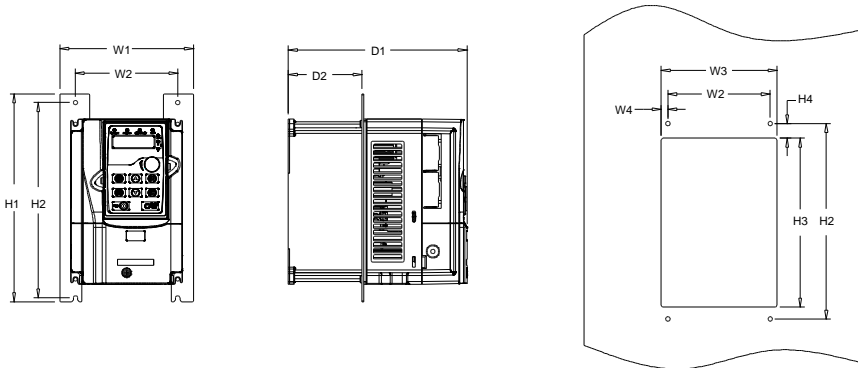

Fig 11.11 Flange installation diagram of inverters of 400 V, 4 to 75 kW

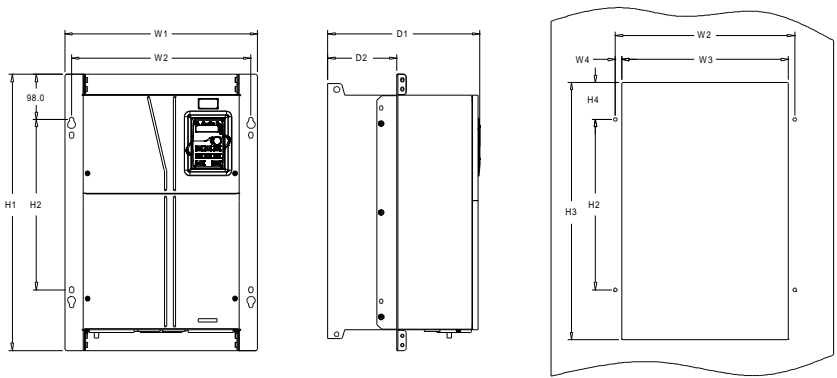

Fig 11.12 Flange installation diagram of inverters of 400 V, 90 to 110 kW

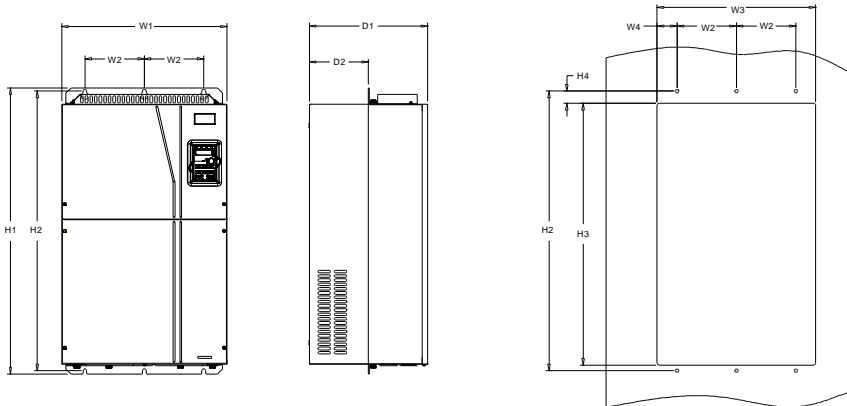

Fig 11.13 Flange installation diagram of inverters of 400 V, 132 to 200 kW

Flange installation dimensions of 400 V inverters (unit: mm)

Inverter specification	W1	W2	W3	W4	H1	H2	H3	H4	D1	D2	Installation hole diameter	Fixing screw
4kW–5.5kW	150.2	115	130	7.5	234	220	190	13.5	201	83	5	M4
7.5kW	170.2	131	150	9.5	292	276	260	6	192	84.5	6	M5
11kW–15kW	191.2	151	174	11.5	370	351	324	12	220	113	6	M5
18.5kW–22kW	266	250	224	13	371	250	350.6	20.3	208	104	6	M5
30kW–37kW	316	300	274	13	430	300	410	55	223	118.3	6	M5
45kW–75kW	352	332	306	12	580	400	570	80	258	133.8	9	M8
90kW–110kW	418.5	389.5	361	14.2	600	370	559	108.5	330	149.5	10	M8

S1 series standard inverter

Inverter specification	W1	W2	W3	W4	H1	H2	H3	H4	D1	D2	Installation hole diameter	Fixing screw
132kW–200kW	500	180	480	60	870	850	796	37	360	178.5	11	M10

11.4.4 Floor installation dimensions

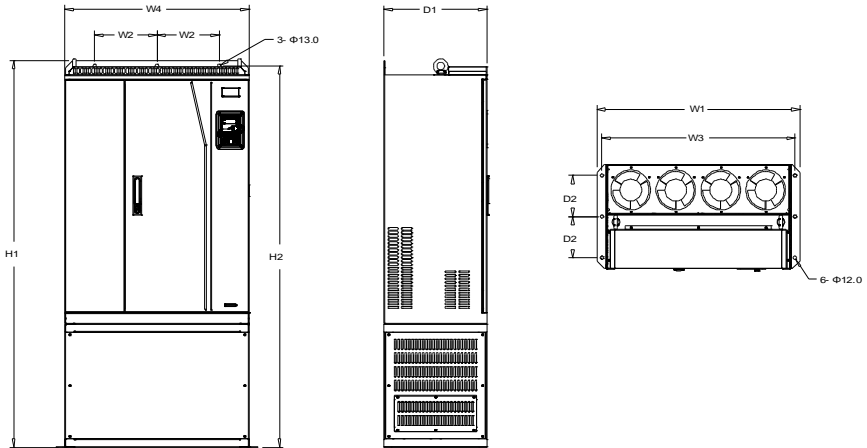

Fig 11.14 Floor installation diagram of inverters of 400 V, 220 to 315 kW

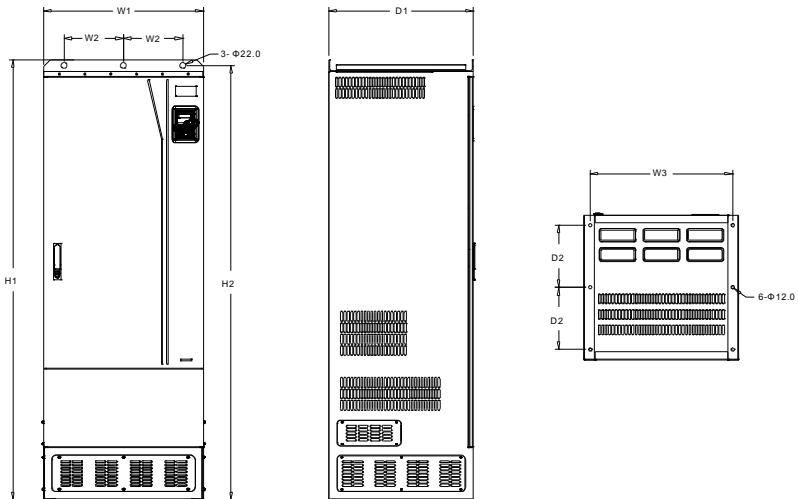

Fig 11.15 Floor installation diagram of inverters of 400 V, 355 to 400 kW



S1 series standard inverter

Floor installation dimensions of 400 V inverters (unit: mm)

Inverter specification	W1	W2	W3	W4	H1	H2	D1	D2	Installation hole diameter	Fixing screw
220kW–315kW	750	230	714	680	1410	1390	380	150	13/12	M12/M10
355kW–400kW	620	230	572	-	1700	1678	560	240	22/12	M20/M10

## Chapter 12 Optional peripheral accessories

### 12.1 What this chapter contains

This chapter describes how to select optional accessories of S1 series inverters.

### 12.2 Wiring of peripheral accessories



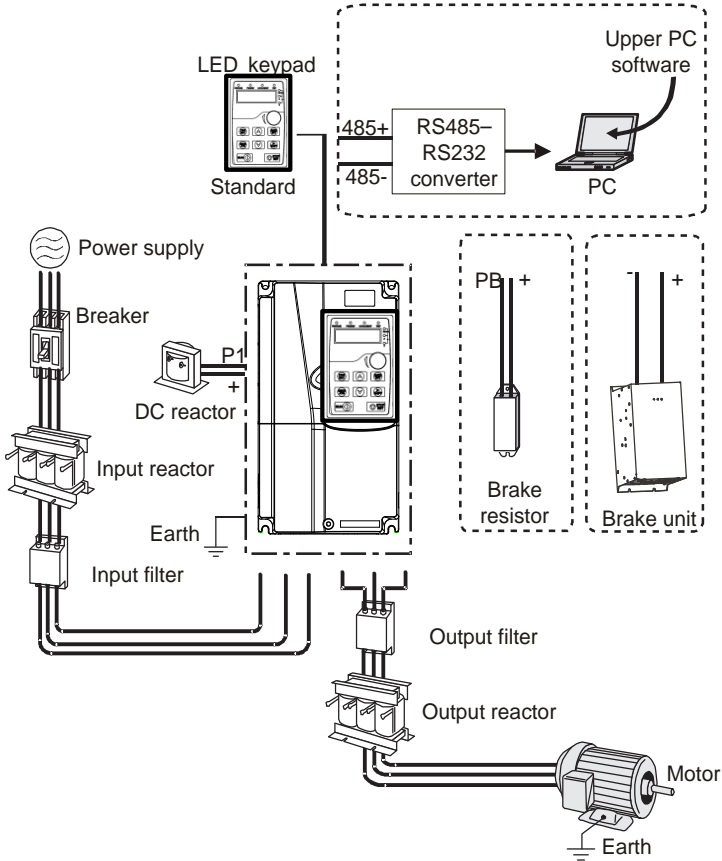



The following figure shows the external wiring of a S1 series inverter.



**Note:**

1. Inverters of 400 V, 18.5 kW to 110 kW are equipped with built-in DC reactors.
2. P1 terminals are equipped only for inverters of 400 V, 132 kW or higher, which enable the inverters to be directly connected to external DC reactors.
3. The brake units HITACHI's DBU series standard brake units. For details, see the DBU operation manual.

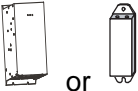
S1 series standard inverter

Image	Name	Description
	Cable	Accessory for signal transmission
	Breaker	Device for electric shock prevention and protection against short-to-ground that may cause current leakage and fire. Select residual-current circuit breakers (RCCBs) that are applicable to inverters and can restrict high-order harmonics, and of which the rated sensitive current for one inverter is larger than 30 mA.
	Input reactor	Accessories used to improve the current adjustment coefficient on the input side of the inverter, and thus restrict high-order harmonic currents. Inverters of 400 V, 132 kW or higher can be directly connected to external DC reactors.
	DC reactor	
	Input filter	Accessory that restricts the electromagnetic interference generated by the inverter and transmitted to the public grid through the power cable. Try to install the input filter near the input terminal side of the inverter.
 or	Brake unit or brake resistor	Accessories used to consume the regenerative energy of the motor to reduce the deceleration time. Inverters 37 kW or lower need only to be configured with brake resistors, those of 400V, 45kW to 55 kW need to be configured with optional built-in brake units, and those of 400V, 75 kW to 400 kW can be configured with optional external brake units.
	Output filter	Accessory used to restrict interference generated in the wiring area on the output side of the inverter. Try to install the output filter near the output terminal side of the inverter.
	Output reactor	Accessory used to lengthen the valid transmission distance of the inverter, which effectively restrict the transient high voltage generated during the switch-on and switch-off of the IGBT module of the inverter.

## 12.3 Power supply

Refer to the electrical installation.

	◇ Ensure that the voltage class of the inverter is consistent with that of the grid.
---	--

## 12.4 Cables

### 12.4.1 Power cables

The sizes of the input power cables and motor cables must meet the local regulation.

- The input power cables and motor cables must be able to carry the corresponding load currents.
- The maximum temperature margin of the motor cables in continuous operation cannot be lower than 70°C.
- The conductivity of the PE grounding conductor is the same as that of the phase conductor, that is, the cross-sectional areas are the same.
- For details about the EMC requirements, see Chapter 10 "Technical data."

To meet the EMC requirements stipulated in the CE standards, you must use symmetrical shielded cables as motor cables (as shown in the following figure).

Four-core cables can be used as input cables, but symmetrical shielded cables are recommended. Compared with four-core cables, symmetrical shielded cables can reduce electromagnetic radiation as well as the current and loss of the motor cables.

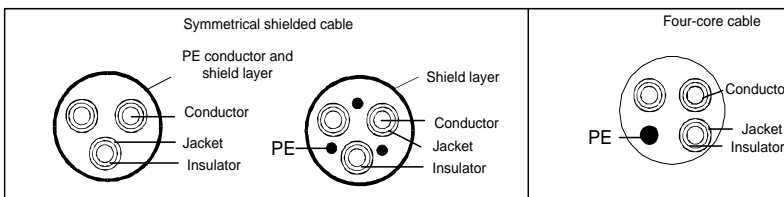

**Note:** If the conductivity of the shield layer of the motor cables cannot meet the requirements, separate PE conductors must be used.

To protect the conductors, the cross-sectional area of the shielded cables must be the same as that of the phase conductors if the cable and conductor are made of materials of the same type. This reduces grounding resistance, and thus improves impedance continuity.

To effectively restrict the emission and conduction of radio frequency (RF) interference, the conductivity of the shielded cable must at least be 1/10 of the conductivity of the phase conductor. This requirement can be well met by a copper or aluminium shield layer. The following figure shows the minimum requirement on motor cables of an inverter. The cable must consist of a layer of spiral-shaped copper strips. The denser the shield layer is, the more effectively the electromagnetic interference is restricted.

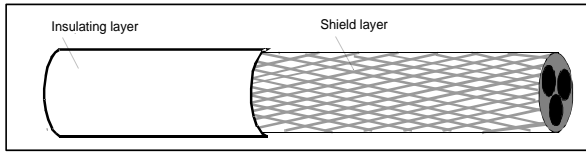

Cross-section of the cable

### 12.4.2 Control cables

All analog control cables and cables used for frequency input must be shielded cables. Analog signal cables need to be double-shielded twisted-pair cables (as shown in figure a). Use one separate shielded twisted pair for each signal. Do not use the same ground wire for different analog signals.

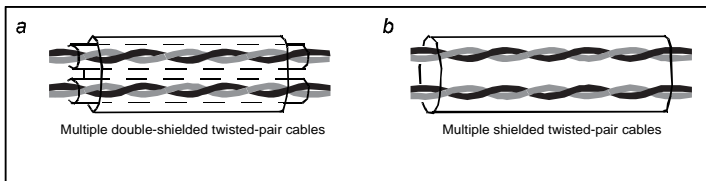

Power cable arrangement

For low-voltage digital signals, double-shielded cables are recommended, but shielded or unshielded twisted pairs (as shown in figure b) also can be used. For frequency signals, however, only shielded cables can be used.

Relay cables need to be those with metal braided shield layers.

Keypads need to be connected by using network cables. In complicated electromagnetic environments, shielded network cables are recommended.

**Note:** Analog signals and digital signals cannot use the same cables, and their cables must be arranged separately.

Do not perform any voltage endurance or insulation resistance tests, such as high-voltage insulation tests or using a megameter to measure the insulation resistance, on the inverter or its components. Insulation and voltage endurance tests have been performed between the main circuit and chassis of each inverter before delivery. In addition, voltage limiting circuits that can automatically cut off the test voltage are configured inside the inverters.

**Note:** Check the insulation conditions of the input power cable of an inverter according to the local regulations before connecting it.

## 12.4.3 Recommended cable sizes

Inverter model	Recommended cable size (mm <sup>2</sup> )		Size of connectable cable (mm <sup>2</sup> )				Terminal specification	Tightening torque (Nm)
	RST UVW	PE	RST UVW	P1, (+)	PB, (+), (-)	PE		
S1-00032SFE	1.5	1.5	1-4	1-4	/	1.5	M3	0.8
S1-00055SFE	1.5	1.5	1-4	1-4	/	1.5	M3	0.8
S1-00100SFE	2.5	2.5	1-4	1-4	/	2.5	M3	0.8
S1-00130SFE	2.5	2.5	1-4	1-4	/	2.5	M3	0.8
S1-00032HFE	1.5	1.5	1-1.5	1-1.5	/	1-1.5	M3	0.8
S1-00055HFE	1.5	1.5	1-1.5	1-1.5	/	1-1.5	M3	0.8
S1-00073HFE	1.5	1.5	1-1.5	1-1.5	/	1-1.5	M3	0.8
S1-00125HFEF	2.5	2.5	2.5-6	2.5-6	2.5-6	2.5-6	M4	1.2-1.5
S1-00170HFEF	2.5	2.5	2.5-6	2.5-6	2.5-6	2.5-6	M4	1.2-1.5
S1-00230HFEF	4	4	2.5-6	4-6	4-6	2.5-6	M4	1.2-1.5
S1-00320HFEF	6	6	4-10	4-10	4-10	4-10	M5	2.3
S1-00380HFEF	6	6	4-10	4-10	4-10	4-10	M5	2.3
S1-00450HFEF	10	10	10-16	10-16	10-16	10-16	M5	2.3
S1-00600HFEF	16	16	10-16	10-16	10-16	10-16	M5	2.3
S1-00750HFEF	25	16	25-50	25-50	25-50	16-25	M6	2.5
S1-00920HFEF	25	16	25-50	25-50	25-50	16-25	M6	2.5
S1-01150HFEF	35	16	35-70	35-70	35-70	16-35	M8	10
S1-01500HFEF	50	25	35-70	35-70	35-70	16-35	M8	10
S1-01700HFEF	70	35	35-70	35-70	35-70	16-35	M8	10
S1-02150HFEF	95	50	70-120	70-120	70-120	50-70	M12	35
S1-02600HFEF	120	70	70-120	70-120	70-120	50-70	M12	35
S1-03050HFEF	185	95	95-300	95-300	95-300	95-240	Nuts are used as terminals, so it is recommended that you use a wrench or sleeve.	
S1-03400HFEF	240	120	95-300	95-300	95-300	120-240		
S1-03800HFEF	95x2P	95	95-150	70-150	70-150	35-95		
S1-04250HFEF	95x2P	120	95x2P -150x2P	95x2P -150x2P	95x2P -150x2P	120-240		
S1-04800HFEF	150x2P	150	95x2P - 150x2P	95x2P - 150x2P	95x2P - 150x2P	150-240		
S1-05300HFEF	95x4P	95x2P	95x4P -150x4P	95x4P -150x4P	95x4P -150x4P	95x2P -150x2P		

S1 series standard inverter

Inverter model	Recommended cable size (mm <sup>2</sup> )		Size of connectable cable (mm <sup>2</sup> )				Terminal screw specification	Tightening torque (Nm)
	RST UVW	PE	RST UVW	P1, (+)	PB, (+), (-)	PE		
S1-06000HFEF	95×4P	95×2P	95×4P -150×4P	95×4P -150×4P	95×4P -150×4P	95×2P -150×2P	Nuts are used as terminals, so it is recommended that you use a wrench or sleeve.	
S1-06500HFEF	95×4P	95×4P	95×4P -150×4P	95×4P -150×4P	95×4P -150×4P	95×2P -150×2P		
S1-07200HFEF	95×4P	95×4P	95×4P -150×4P	95×4P -150×4P	95×4P -150×4P	95×2P -150×2P		
S1-08600HFEF	150×4P	150×2P	95×4P -150×4P	95×4P -150×4P	95×4P -150×4P	95×2P -150×2P		

**Note:**

1. Cables of the sizes recommended for the main circuit can be used in scenarios where the ambient temperature is lower than 40°C, the wiring distance is shorter than 100 m, and the current is the rated current.
2. The terminals P1, (+), and (-) are used to connect to DC reactors and brake accessories.

**12.4.4 Cable arrangement**

Motor cables must be arranged away from other cables. The motor cables of several inverters can be arranged in parallel. It is recommended that you arrange the motor cables, input power cables, and control cables separately in different trays. The output dU/dt of the inverters may increase electromagnetic interference on other cables. Do not arrange other cables and the motor cables in parallel.

If a control cable and power cable must cross each other, ensure that the angle between them is 90 degrees.

The cable trays must be connected properly and well grounded. Aluminum trays can implement local equipotential.

The following figure shows the cable arrangement distance requirements.

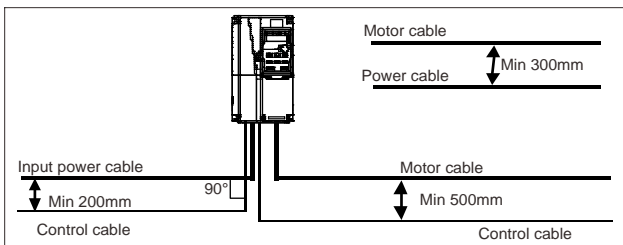

### 12.4.5 Insulation inspection

Check the motor and the insulation conditions of the motor cable before running the motor.

1. Ensure that the motor cable is connected to the motor, and then remove the motor cable from the U, V, and W output terminals of the inverter.
2. Use a megameter of 500 V DC to measure the insulation resistance between each phase conductor and the protection grounding conductor. For details about the insulation resistance of the motor, see the description provided by the manufacturer.

**Note:** The insulation resistance is reduced if it is damp inside the motor. If it may be damp, you need to dry the motor and then measure the insulation resistance again.

### 12.5 Breaker and electromagnetic contactor

You need to add a fuse to prevent overload.

You need to configure a manually manipulated molded case circuit breaker (MCCB) between the AC power supply and inverter. The breaker must be locked in the open state to facilitate installation and inspection. The capacity of the breaker needs to be 1.5 to 2 times the rated current of the inverter.

	<p>◇ According to the working principle and structure of breakers, if the manufacturer's regulation is not followed, hot ionized gases may escape from the breaker enclosure when a short-circuit occurs. To ensure safe use, exercise extra caution when installing and placing the breaker. Follow the manufacturer's instructions.</p>
---	---

To ensure safety, you can configure an electromagnetic contactor on the input side to control the switch-on and switch-off of the main circuit power, so that the input power supply of the inverter can be effectively cut off when a system fault occurs.

Inverter model	Fuse (A)	Breaker (A)	Rated current of the contactor (A)
S1-00032SFE	10	10	9
S1-00055SFE	16	16	12
S1-00100SFE	25	25	25
S1-00130SFE	50	40	32
S1-00032HFE	6	6	9
S1-00055HFE	10	10	9
S1-00073HFE	10	10	9
S1-00125HFEF	30	25	16
S1-00170HFEF	45	25	16
S1-00230HFEF	60	40	25
S1-00320HFEF	78	63	32
S1-00380HFEF	105	63	50
S1-00450HFEF	114	100	63
S1-00600HFEF	138	100	80
S1-00750HFEF	186	125	95
S1-00920HFEF	228	160	120
S1-01150HFEF	270	200	135



Inverter model	Fuse (A)	Breaker (A)	Rated current of the contactor (A)
S1-01500HFEF	315	200	170
S1-01700HFEF	420	250	230
S1-02150HFEF	480	315	280
S1-02600HFEF	630	400	315
S1-03050HFEF	720	400	380
S1-03400HFEF	870	630	450
S1-03800HFEF	1110	630	580
S1-04250HFEF	1110	630	580
S1-04800HFEF	1230	800	630
S1-05300HFEF	1380	800	700
S1-06000HFEF	1500	1000	780
S1-06500HFEF	1740	1200	900
S1-07200HFEF	1860	1280	960
S1-08600HFEF	2010	1380	1035

**Note:** The accessory specifications described in the preceding table are ideal values. You can select accessories based on the actual market conditions, but try not to use those with lower values.

## 12.6 Reactors

When the voltage of the grid is high, the transient large current that flows into the input power circuit may damage rectifier components. You need to configure an AC reactor on the input side, which can also improve the current adjustment coefficient on the input side.

When the distance between the inverter and motor is longer than 50 m, the parasitic capacitance between the long cable and ground may cause large leakage current, and overcurrent protection of the inverter may be frequently triggered. To prevent this from happening and avoid damage to the motor insulator, compensation must be made by adding an output reactor. When an inverter is used to drive multiple motors, take the total length of the motor cables (that is, sum of the lengths of the motor cables) into account. When the total length is longer than 50 m, an output reactor must be added on the output side of the inverter. If the distance between the inverter and motor is 50 m to 100 m, select the reactor according to the following table. If the distance is longer than 100 m, contact HITACHI's technical support technicians.

DC reactors can be directly connected to inverters of 400 V, 132 kW or higher. DC reactors can improve the power factor, avoid damage to bridge rectifiers caused due to large input current of the inverter when large-capacity transformers are connected, and also avoid damage to the rectification circuit caused due to harmonics generated by grid voltage transients or phase-control loads.

S1 series standard inverter

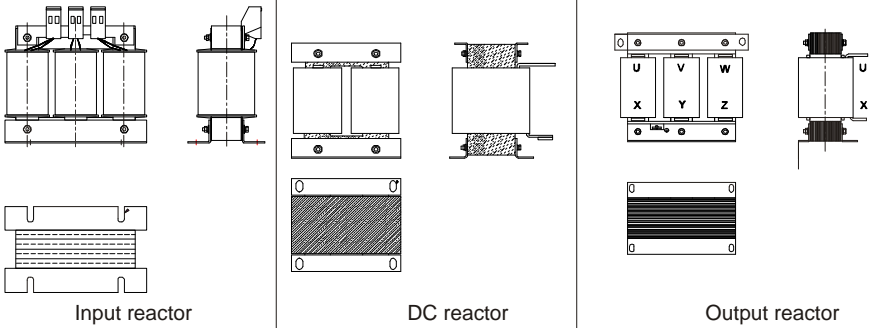

Reactor models

Inverter model	Input reactor	DC reactor	Output reactor
S1-00032SFE	/	/	/
S1-00055SFE	/	/	/
S1-00100SFE	/	/	/
S1-00130SFE	/	/	/
S1-00032HFE	ACR-1R5-4	/	OCR-1R5-4
S1-00055HFE	ACR-1R5-4	/	OCR-1R5-4
S1-00073HFE	ACR-2R2-4	/	OCR-2R2-4
S1-00125HFEF	ACR-004-4	/	OCR-004-4
S1-00170HFEF	ACR-5R5-4	/	OCR-5R5-4
S1-00230HFEF	ACR-7R5-4	/	OCR-7R5-4
S1-00320HFEF	ACR-011-4	/	OCR-011-4
S1-00380HFEF	ACR-015-4	/	OCR-015-4
S1-00450HFEF	ACR-018-4	/	OCR-018-4
S1-00600HFEF	ACR-022-4	/	OCR-022-4
S1-00750HFEF	ACR-037-4	/	OCR-037-4
S1-00920HFEF	ACR-037-4	/	OCR-037-4
S1-01150HFEF	ACR-045-4	/	OCR-045-4
S1-01500HFEF	ACR-055-4	/	OCR-055-4
S1-01700HFEF	ACR-075-4	/	OCR-075-4
S1-02150HFEF	ACR-0110-4	/	OCR-110-4
S1-02600HFEF	ACR-110-4	/	OCR-110-4
S1-03050HFEF	ACR-160-4	DCR-132-4	OCR-200-4
S1-03400HFEF	ACR-160-4	DCR-160-4	OCR-200-4
S1-03800HFEF	ACR-200-4	DCR-200-4	OCR-200-4
S1-04250HFEF	ACR-200-4	DCR-220-4	OCR-200-4

## S1 series standard inverter

Inverter model	Input reactor	DC reactor	Output reactor
S1-04800HFEF	ACR-280-4	DCR-280-4	OCR-280-4
S1-05300HFEF	ACR-280-4	DCR-280-4	OCR-280-4
S1-06000HFEF	ACR-280-4	DCR-280-4	OCR-280-4
S1-06500HFEF	ACR-350-4	DCR-315-4	OCR-350-4
S1-07200HFEF	Integrated	DCR-400-4	OCR-350-4
S1-08600HFEF	Integrated	DCR-400-4	OCR-400-4

### Note:

1. The rated input voltage drop of input reactors is  $2\% \pm 15\%$ .
2. The current adjustment coefficient on the input side of the inverter is higher than 90% after a DC reactor is configured.
3. The rated output voltage drop of output reactors is  $1\% \pm 15\%$ .
4. The preceding table describes external accessories. You need to specify the ones you choose when purchasing accessories.

## 12.7 Filters

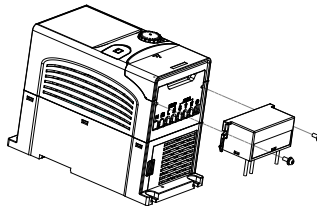

Up to 2.2kW models the installation procedures for C3 filter are as below:

1. Connect the filter cable to the corresponding input terminal of the inverter according to the label;
2. Fix the filter onto the inverter with M3\*10 screws (as shown in above picture).

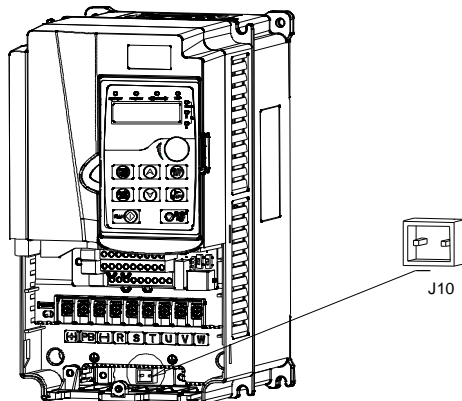

**Note:** All S1 models starting from 4kW and bigger have a built-in class C3 EMC filter. The C3 filter is

selectable and can be enabled or disabled by the Jumper J10. The default setting (factory setting) is that the C3 Filter is enabled which means the jumper J10 is inserted. If required, please remove the jumper J10 to disable the integrated C3 filter.

Disconnect J10 in the following situations:

1. The EMC filter is applicable to the neutral-grounded grid system. If it is used for the IT grid system (that is, non-neutral grounded grid system), disconnect J10.
2. If leakage protection occurs during configuration of a residual-current circuit breaker, disconnect J10.

Interference filters on the input side can reduce the interference of inverters (when used) on the surrounding devices.



Noise filters on the output side can decrease the radio noise caused by the cables between inverters and motors and the leakage current of conducting wires.

HITACHI provides some of the filters for users to choose.

## 12.8 Brake system

### 12.8.1 Brake component selection

When an inverter driving a high-inertia load decelerates or needs to decelerate abruptly, the motor runs in the power generation state and transmits the load-carrying energy to the DC circuit of the inverter, causing the bus voltage of the inverter to rise. If the bus voltage exceeds a specific value, the inverter reports an overvoltage fault. To prevent this from happening, you need to configure brake components.

	<ul style="list-style-type: none"> <li>◇ The design, installation, commissioning, and operation of the device must be performed by trained and qualified professionals.</li> <li>◇ Follow all the "Warning" instructions during the operation. Otherwise, major physical injuries or property loss may be caused.</li> <li>◇ Only qualified electricians are allowed to perform the wiring. Otherwise, damage to the inverter or brake components may be caused.</li> <li>◇ Read the brake resistor or unit instructions carefully before connecting them to the inverter.</li> <li>◇ Connect brake resistors only to the terminals PB and (+), and brake units only to the terminals (+) and (-). Do not connect them to other terminals. Otherwise, damage to the brake circuit and inverter and fire may be caused.</li> </ul>
	<ul style="list-style-type: none"> <li>◇ Connect the brake components to the inverter according to the wiring diagram. If the wiring is not properly performed, damage to the inverter or other devices may be caused.</li> </ul>



#### Brake unit models

Inverter model	Brake unit model	Resistance applicable for 100% brake torque (Ω)	Dissipated power of brake resistor (kW)	Dissipated power of brake resistor (kW)	Dissipated power of brake resistor (kW)	Min. allowable brake resistance (Ω)
			10% brake usage	50% brake usage	80% brake usage	
S1-00032SFE	Built-in brake unit	361	0.06	0.30	0.48	42
S1-00055SFE		192	0.11	0.56	0.90	42
S1-00100SFE		96	0.23	1.10	1.80	30
S1-00130SFE		65	0.33	1.70	2.64	21
S1-00032HFE		653	0.11	0.56	0.90	240
S1-00055HFE		326	0.23	1.13	1.80	170
S1-00073HFE		222	0.33	1.65	2.64	130
S1-00125HFEF		122	0.6	3	4.8	80
S1-00170HFEF		89	0.75	4.1	6.6	60
S1-00250HFEF		65	1.1	5.6	9	47

Inverter model	Brake unit model	Resistance applicable for 100% brake torque ( $\Omega$ )	Dissipated power of brake resistor (kW)	Dissipated power of brake resistor (kW)	Dissipated power of brake resistor (kW)	Min. allowable brake resistance ( $\Omega$ )
			10% brake usage	50% brake usage	80% brake usage	
S1-00320HFEF		44	1.7	8.3	13.2	31
S1-00380HFEF		32	2	11	18	23
S1-00450HFEF		27	3	14	22	19
S1-00600HFEF		22	3	17	26	17
S1-00750HFEF		17	5	23	36	17
S1-00920HFEF		13	6	28	44	11.7

**Note:**

1. Select brake resistors according to the resistance and power data provided by our company.
2. The brake resistor may increase the brake torque of the inverter. The preceding table describes the resistance and power for 100% brake torque, 10% brake usage, 50% brake usage, and 80% brake usage. You can select the brake system based on the actual operation conditions.
3. When using an external brake unit, set the brake voltage class of the brake unit properly by referring to the manual of the dynamic brake unit. If the voltage class is set incorrectly, the inverter may not run properly.

	⋄ Do not use brake resistors whose resistance is lower than the specified minimum resistance. Inverters do not provide protection against overcurrent caused by resistors with low resistance.
	⋄ In scenarios where brake is frequently implemented, that is, the brake usage is greater than 10%, you need to select a brake resistor with higher power as required by the operation conditions according to the preceding table.

**12.8.2 Brake resistor cable selection**

Brake resistor cables need to be shielded cables.

**12.8.3 Brake resistor installation**

All resistors need to be installed in places with good cooling conditions.

	⋄ The materials near the brake resistor or brake unit must be non-flammable. The surface temperature of the resistor is high. Air flowing from the resistor is of hundreds of degrees Celsius. Prevent any materials from coming into contact with the resistor.
---	--

Installation of brake resistors

	⋄ Inverters (37 kW or lower) need only external brake resistors. ⋄ PB and (+) are the terminals for connecting brake resistors.
---	--

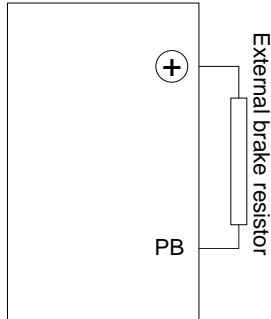

Installation of brake units

	◇ (+) and (-) are the terminals for connecting brake units.
	◇ The connection cables between the (+) and (-) terminals of an inverter and those of a brake unit must be shorter than 5 m, and the connection cables between the BR1 and BR2 terminals of a brake unit and the terminals of a brake resistor must be shorter than 10 m.

The following figure shows the connection of one inverter to a dynamic brake unit.

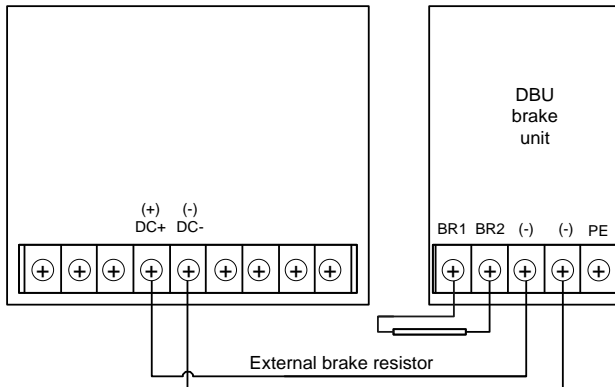

## Chapter 13 STO function description

Reference standards: IEC 61508-1, IEC 61508-2, IEC 61508-3, IEC 61508-4, IEC 62061, ISO 13849-1, and IEC 61800-5-2

You can enable the safe torque off (STO) function to prevent unexpected startups when the main power supply of the drive is not switched off. The STO function switches off the drive output by turning off the drive signals to prevent unexpected startups of the motor (see the following figure). After the STO function is enabled, you can perform some-time operations (such as non-electrical cleaning in the lathe industry) and maintain the non-electrical components of the device without switching off the drive.

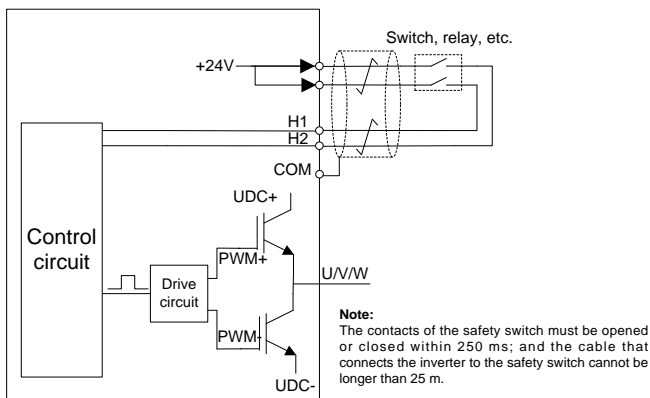

### 13.1 STO function logic table

The following table describes the input states and corresponding faults of the STO function.

STO input state	Corresponding fault
H1 and H2 opened simultaneously	The STO function is triggered, and the drive stops running. Fault code: 40: Safe torque off (STO)
H1 and H2 closed simultaneously	The STOP function is not triggered, and the drive runs properly.
One of H1 and H2 opened, and the other closed	The STL1, STL2, or STL3 fault occurs. Fault code: 41: Channel H1 exception (STL1) 42: Channel H2 exception (STL2) 43: Channel H1 and H2 exceptions (STL3)



### 13.2 STO channel delay description

The following table describes the trigger and indication delay of the STO channels.

STO mode	STO trigger and indication delay <sup>1,2</sup>
STO fault: STL1	Trigger delay < 10 ms Indication delay < 280 ms
STO fault: STL2	Trigger delay < 10 ms Indication delay < 280 ms
STO fault: STL3	Trigger delay < 10 ms Indication delay < 280 ms
STO fault: STO	Trigger delay < 10 ms Indication delay < 100 ms

1. STO function trigger delay: Time interval between trigger the STO function and switching off the drive output
2. STO instruction delay: Time interval between trigger the STO function and STO output state indication

### 13.3 STO function installation checklist

Before installing the STO, check the items described in the following table to ensure that the STO function can be properly used.

	Item
<input type="checkbox"/>	Ensure that the drive can be run or stopped randomly during commissioning.
<input type="checkbox"/>	Stop the drive (if it is running), disconnect the input power supply, and isolate the drive from the power cable through the switch.
<input type="checkbox"/>	Check the STO circuit connection according to the circuit diagram.
<input type="checkbox"/>	Check whether the shielding layer of the STO input cable is connected to the +24 V reference ground COM.
<input type="checkbox"/>	Connect the power supply.
<input type="checkbox"/>	Test the STO function as follows after the motor stops running: <ul style="list-style-type: none"> <li>• If the drive is running, send a stop command to it and wait until the shaft of the motor stops rotating.</li> <li>• Activate the STO circuit and send a start command to the drive. Ensure that the motor does not start.</li> <li>• Deactivate the STO circuit.</li> </ul>
<input type="checkbox"/>	Restart the drive, and check whether the motor is running properly.
<input type="checkbox"/>	Test the STO function as follows when the motor is running: <ul style="list-style-type: none"> <li>• Start the drive. Ensure that the motor is running properly.</li> <li>• Activate the STO circuit.</li> <li>• The drive reports an STO fault (for details, see section 7.5 "Inverter faults and solutions"). Ensure that the motor coasts to stop rotating.</li> <li>• Deactivate the STO circuit.</li> </ul>
<input type="checkbox"/>	Restart the drive, and check whether the motor is running properly.

## **Chapter 14 Further information**

### **14.1 Product and service queries**

Should you have any queries about the product, contact the local HITACHI office. Provide the model and serial number of the product you query about. You can visit [www.HITACHI.com](http://www.HITACHI.com) to find a list of HITACHI offices.

### **14.2 Feedback on HITACHI inverter manuals**

Your comments on our manuals are welcome. Visit [www.HITACHI.com](http://www.HITACHI.com), directly contact online service personnel or choose **Contact Us** to obtain contact information.

### **14.3 Documents on the Internet**

You can find manuals and other product documents in the PDF format on the Internet. Visit [www.hitachi-industrial.com](http://www.hitachi-industrial.com).

# HITACHI

## Inspire the Next

Hitachi Europe GmbH, Niederkasseler Lohweg 191, D-40547 Düsseldorf  
Phone: +49 (0) 211-5283-0  
[www.hitachi-industrial.eu](http://www.hitachi-industrial.eu), [automation.industrial@hitachi-eu.com](mailto:automation.industrial@hitachi-eu.com)

All company and product names in this basic guide  
are the property of the respective companies.